



OUR PRODUCTS



2

10

ABOUT A2S

Our quality	2	Our customer service	6
How we develop our classics	4	Size labeling	8

CHAIRS

Overview chairs	10	Solid wood chairs	26
Chairs with plastic shell, FLEX	12	Office swivel chairs	28
Chairs with PAGHOLZ® shell	14	Conference and office swivel chair WAVE	30
Chairs and tables with PAGHOLZ® shell, CHANGE	18	Conference chair	32
Chairs with Multiplex/WOODMARK/Plastic shell	20	Upholstered/lounge chair	33
Chairs with Multiplex shell	22	Stools	34
		Benches	36
		Standing/sitting combinations	38

TABLES

Overview tables	42
Classroom tables metal	44
Classroom tables solid wood	50
Classroom tables, height-adjustable	54
Office desks, height-adjustable	60
Mono-column tables, height-adjustable	62
Teacher's desks	64
Specialist room tables/computer tables	66
Multi-functional tables	68
Side folding tables	70
Folding tables	72
Plate base tables	77
Metal table system, demountable	78
Metal table system, welded	82
Wooden tables	86
Accessories for table systems	88
Table partition wall system	90
Rolling containers and base units	92
Containers/pull-out pantries	94

CORPUS FURNITURE

Overview corpus furniture	96
Corpus furniture system	98
Corpus furniture for learning spaces	108
Hallway furniture system	118
Organizing systems	120
Display cases, administration	122
Corpus furniture for administration	124

LOUNGE FURNITURE/ACOUSTICS

Overview lounge furniture/acoustics	126
CHILL House/Meeting House	128
DOMINO and MAZE Series	130
DOMINO House	132
Upholstered stool CYLINDA/BLOC	133
COMFORT HI	134
Folding couch and armchair	135
Beanbag and seat cushion CHILL Series	136
COMBI acoustic partition walls	138
Acoustic elements	140

BOARDS

Overview boards	142
Multifunctional board system	144
Display DURAVISION	146
Digital boards DURABOARD	148
Long wall boards	150
Sliding boards	151
Pylon boards	152
Bogie boards/light screens	154
Rulings and accessories	155

PRODUCTS AND MATERIALS

Tabletops and surfaces	156
Table edges	158
PAGHOLZ®	159
The A2S Service	160

42

96

126

142

156



Our furniture is manufactured by 400 employees in Germany, because short distances protect the environment.

**MADE
IN
GERMANY**



A GOOD EXAMPLE OF EDUCATION.

The careful use of resources stands for our conviction that quality and sustainability belong together. As educational institution, we have a special responsibility in this respect: Our products will shape future generations.

This is precisely why we are committed to carefully treating nature and the environment by

- avoiding tropical woods
- not using substances containing solvents
- remaining significantly below the legal emission limits
- producing low-dust and low-sound
- reducing packaging
- efficiently disposing of waste

We would be delighted if this commitment is to be rewarded: Our products are repeatedly awarded numerous seals of approval and certificates. This motivates us every day anew to put safety and quality into practice. And to work on many new developments that we make transparent - through regular checks by independent experts and in our own laboratory. Because quality is the benchmark for us, today and tomorrow.

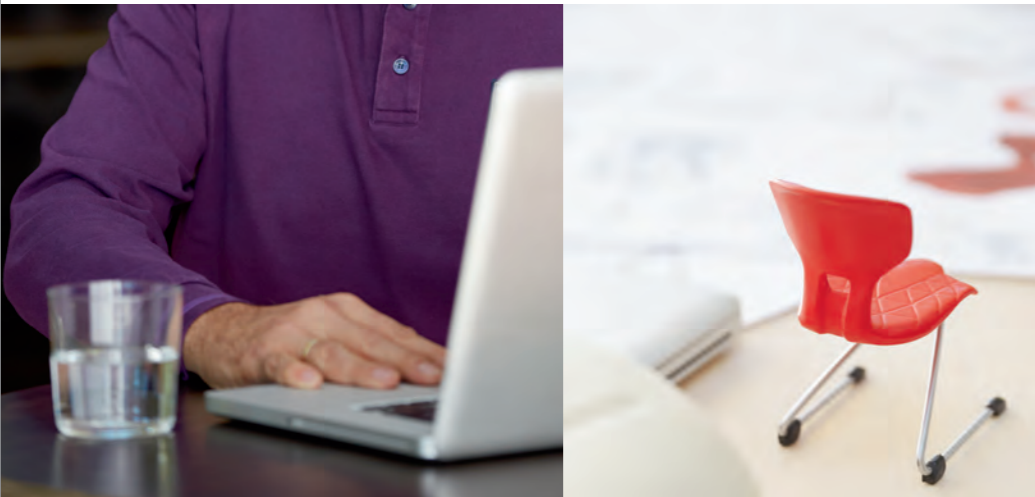

OUR MOST IMPORTANT TOOL: THE EAR.

When we at A2S develop a new product, the first thing we do is work with our ears. Our experience tells us: Our customers know exactly what requirements the ideal chair or table must meet. That is why we take the time to listen to them in peace. The result is furniture such as Flex, which enables flexible learning and can cope with the tough everyday school life. Flex is full of intelligent ideas: Its waisted backrest allows people to sit upside down from time

to time, so that the "owners" can stay healthy in motion. Also its floor protectors are not only gentle on the floor, but also on the nerves. Flex is just one of many examples to show: For designing and realisation of our chairs and tables we love to learn from our customers. Our field service advises you already during planning and conception of your rooms and can thus take all wishes and requirements into

account. In order to give you an idea of how living and working with our ideas will change, we present photorealistic drafts of your plans in advance. This is how rooms are created according to your ideas - with A2S as your competent partner.



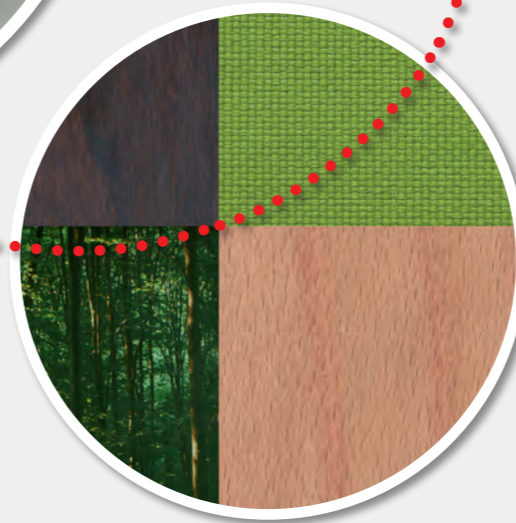
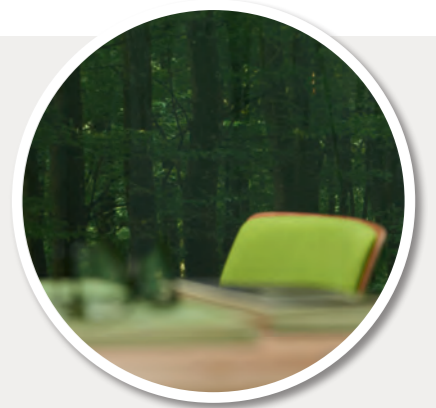
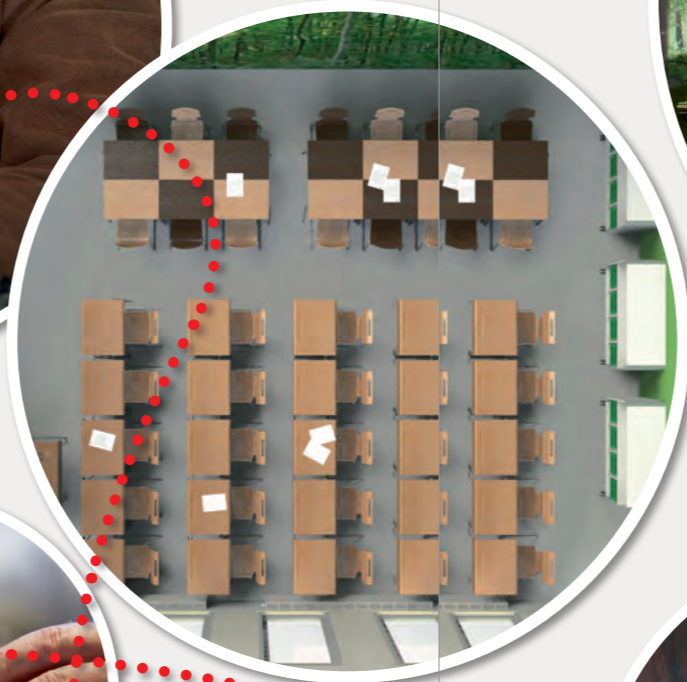
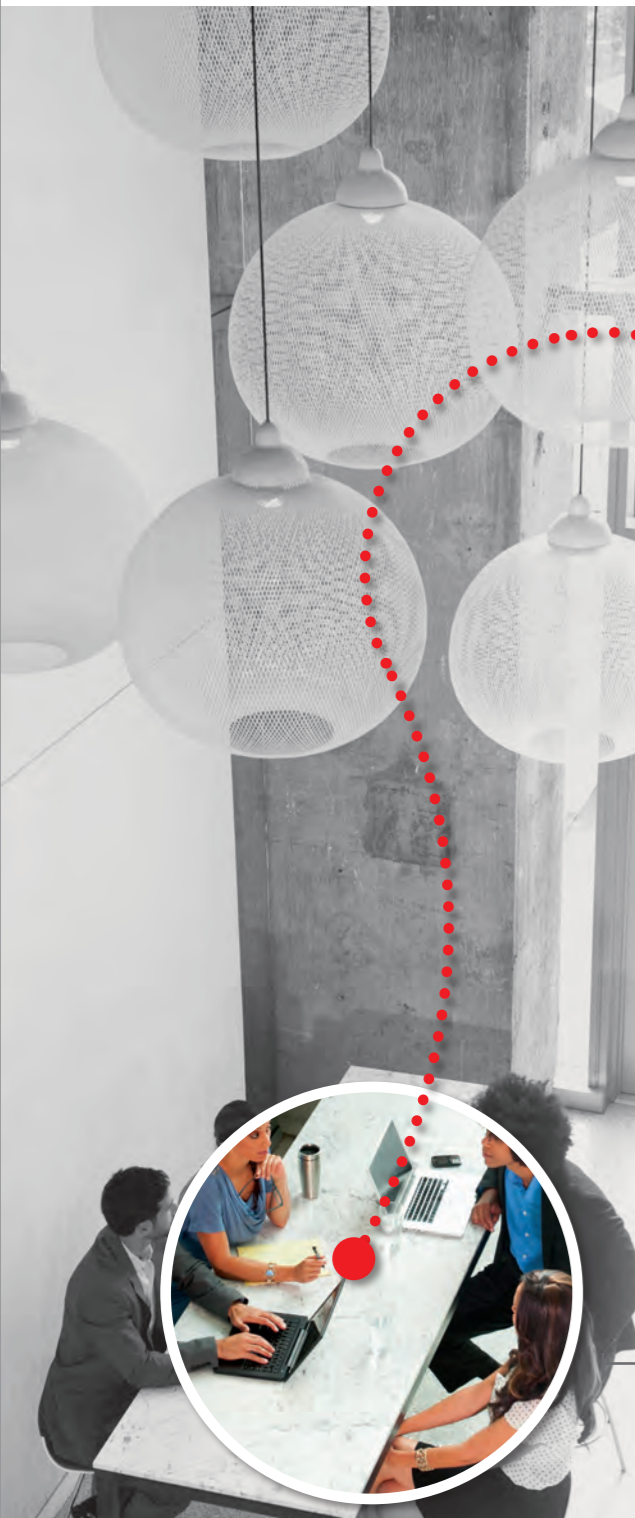

WE'RE HERE FOR YOU.

Our customer service department takes care of everything else, so that you can concentrate fully on your educational work. And that even before you buy anything from us: Our sales representatives will be happy to inform and advise you on site and discuss all your wishes with you. The A2S planners set everything up according to your ideas and,

if desired, visualise the planned room photorealistically in advance. We deliver your furniture mostly pre-assembled, some larger pieces we assemble on site. In the unlikely event that something does not meet your expectations or a spare part is required, we will resolve the issue, quickly and reliably - and that's a promise!



SIZE 2

Pupil size 108-121 cm
Table height 53 cm
Seat height 31 cm



SIZE 3

Pupil size 119-142 cm
Table height 59 cm
Seat height 35 cm



SIZE 4

Pupil size 133-159 cm
Table height 64 cm
Seat height 38 cm



SIZE 5

Pupil size 146-176 cm
Table height 71 cm
Seat height 43 cm



SIZE 6

Pupil size 159-188 cm
Table height 76 cm
Seat height 46 cm



SIZE 7

Pupil size 174-207 cm
Table height 82 cm
Seat height 51 cm



CHILDREN BECOME PEOPLE.

































Children often grow faster than you think. It is therefore particularly important to take into account in spatial planning that a first-grader can grow up to 80 cm taller before he or she is finally full-grown. If you check every six months whether the tables and chairs still have the right height for all students, you are on the safe side: Is the foot position still correct? Are the elbows at the same level as the table surface when sitting upright?

Furniture from A2S offers six size divisions, which can be easily distinguished thanks to their coloured labelings. There is also an extra size with an extra wide seat available for all pupils and adults who are a little more strongly built.

Due to this, you can always be sure that everyone is sitting well and comfortably - no matter what stage of growth someone is currently in.



A2S CHAIR SERIES

Plastic			12	20								
PAGHOLZ® Woodmark						14	16	18	30	20		
Multiplex						20	22	22	24	24		
Solid wood						26	27	27				
Office chairs Conference chairs Upholstered chairs							28	28	30	30	32	33
Stools Benches							34	34	34	34	36	36
Standing/sitting combinations						38	39	39	40	40		

Further frame variants and all options for the chairs shown can be found on the pages indicated.



7853
FLEX with the worldwide patented Z-shaped frame

FLEX | PLASTIC SHELL

- ergonomically shaped plastic shell made of robust, recyclable polypropylene in 7 attractive colors, see A2S material overview
- inverted sitting, saddle sitting and casual sitting are additionally supported by the design
- easy cleaning due to special A2S surface structure
- channel for ventilation and relief of the spinal column
- grip hole in the lordosis area, grip recesses on the upper back edge and underside of the chair
- available in many different frame shapes or with base also in powder coating, the color selection of the steel colors can be found on our A2S material overview

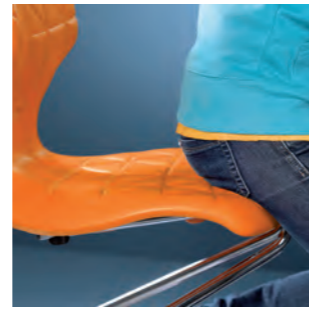

Supports the toning of the muscles through its ergonomic shape and promotes variable, fatigue-free sitting, e.g. saddle sitting



FLEX seat shell with integrated ventilation ducts. The closed surface prevents soiling and thus the formation of mould inside the shell



A2S floorsafe® floor protectors protect the underground, even when tilted, Patent # 10 2010 039 292 A1



7854 FLEX C-shape with cross brace, with A2S floorsafe® floor protectors, lifttable



7874.002 FLEX 4-legged with writing surface



7416.036 FLEX footrest chair with large seat shell and comfortable one-handed operation*



7854 FLEX C-shape with upholstery









7873/7876 FLEX gas-lift swivel chair



7873.002 FLEX gas-lift swivel chair with foot ring

78 SERIES | FLEX

						
MODEL	7874	7853	7854	7416.035/036	7876/7873	7875
Powder-coated frame	4-legs	Z-shape	C-shape	Footrest chair	Gas-lift I/II	Turning spindle
Powder-coated base					Aluminium	Steel
Size	2-7	2-7	2-7	2-4/3-4, 40 cm	3-5/5-7	5-7
Seat height				52 cm/48 cm	33-43/41-54 cm	41-53 cm
Weight · size 6	5.4 kg	6.3 kg	5.4 kg	6.2 kg/7.3 kg	7.3 kg	7.4 kg
Stackability	5 pieces	2 pieces	4 pieces	3 pieces		

OPTIONS

Chrome-plated frame	■	■	■	■	Polished ALU	Polished ALU
Upholstery shell · size 5-7	■	■	■	■	- / ■	■
A2S floorsafe®	■	■	including	■		
Felt floor protectors	■	■	■	■	■	■
Row connection			■			
Table suspension					- / 7873.005	
Castors, load-dependent braking					■	■
3-D rocker mechanism					■	
Partial foot ring					- / ■	
Elevation with foot ring 53-73 cm						7873.002
Cross brace · size 5-7			■			
Book storage basket · size 5-7	■		■			
Writing surface · size 6/7					7874.002	

*The adjustable footrest allows small and large children to sit together at the same table - learning at eye level



7811 PAGHOLZ®
C-shape sliding chair,
5 chairs stackable



Resistant to chemicals



Scratch- and wear-resistant



Shock- and break-proof

78 SERIES | PAGHOLZ® SHELL

- PAGHOLZ® shell: resilient because it is scratch- and impact-resistant, break-proof and glow-resistant, water resistant and flexible (info p. 159)
- ergonomically adapted shell shape or any size from 2-7 (info p. 8-9)
- individual seat depth for each shell size
- optional with round or oval grip hole on top
- PAGHOLZ® shell in color wood stained possible, see A2S material overview
- seat and back upholstery possible in fabric groups 1-4, see A2S material overview
- available in many different frame shapes or with base also in powder coating, the color selection of the steel colors can be found on our A2S material overview



7805 Sliding chair with seat upholstery



7850.012 Four-legged chair with writing surface



7416.032 Footrest chair with large seat shell and comfortable one-hand operation*



7899 Bar stool



8385.002 Gas-lift swivel chair with foot ring



8345/8385 Gas-lift swivel chair with partial foot ring

78 SERIES | PAGHOLZ® SHELL



MODEL	7800/7805	7850	7811	7416.031/.032	7899	8345/8385	7847
Powder-coated frame	Sliding chair	4-legged	C-shape	Footrest chair	Bar stool	Gas-lift I/II	Turning spindle
Powder-coated base						Aluminium	Steel
Size	2-7/6E	4, 5, 6E, 7	2-7	2-4/3-4, 40 cm		3-5/5-7	5-7
Seat height				52 cm/48 cm	78 cm	31-42 cm/ 41-56 cm	40-58 cm
Weight · size 6	4.8 kg/5 kg	5.1 kg	5 kg	5.8 kg/6 kg	8.5 kg	7.5 kg/9 kg	6.2 kg
Stackability · size 6	7 pieces	10 pieces	5 pieces	3 pieces			

OPTIONS

Chrome-plated frame	■	■	■	■	■	■	Polished ALU
PAGHOLZ® shell color wood	■	■	■	■	■	■	■
A2S floorsafe®							including
Felt floor protector	■	■	■	■	■	■	■
Upholstery seat/back only 6E, 7	- / ■	■	■	■	■	- / ■	■
Row connection		7860	■				
Table suspension						- / ■	
Handle hole (n.w. back upholstery)	■	■	■	■	■	■	■
Castors, load-dependent braking						■	7849
2-D rocker mechanism lockable						■	
Partial foot ring						- / ■	
Elevation with foot ring 46-66 cm							8385.002
Cross brace · size 5-7			■				
Writing surface only 6E				7850.012			

*The adjustable footrest allows small and large children to sit together at the same table





7200 Sliding chair PAGHOLZ® shell nature
15 pieces stackable



Resistant to chemicals



Scratch- and wear-resistant



Shock- and break-proof

72 SERIES | PAGHOLZ® SHELL

- ergonomically adapted shell shape in sizes 2-7, thus universally applicable
- PAGHOLZ® shell: CO₂-neutral through natural materials, therefore very ecological (info p. 159)
- extra stable shape with comfortable, straight back
- optional with round or oval grip hole on top
- PAGHOLZ® shell in color wood stained possible, see A2S material overview
- seat and back upholstery possible in fabric groups 1-4, see A2S material overview
- available in many different frame shapes or with base also in powder coating, the color selection of the steel colors can be found on our A2S material overview



7205 Sliding chair



3305 Four-legged chair



7307 C-shape sliding chair



8346/8386 Gas-lift swivel chair



8386 Gas-lift swivel chair with partial foot ring



8386.002 Raised gas-lift swivel chair with foot ring

72 SERIES | PAGHOLZ® SHELL



MODEL	7200/7205	3305	7307	8346/8386	7846
Powder-coated frame	Sliding chair	4-legged	C-shape	Gas-lift I/II	Turning spindle
Powder-coated base				Aluminium	Steel
Size	2-7/6E, 7	6E, 7	2-7, 6E	3-5/5-7	5-7
Height adjustability				31-42/41-56 cm	40-58 cm
Weight · size 6	4.9 kg	4.4 kg	4.9 kg	6.1 kg/8 kg	6.3 kg
Stackability without upholstery · size 6	15 pieces	13 pieces	5 pieces		

OPTIONS

Chrome-plated frame	■	■	■	Polished ALU	
PAGHOLZ® shell color wood	■	■	■	■	■
A2S floorsafe®			including		
Felt floor protectors	■	■	■	■	■
Upholstery seat/back only 6E, 7	- / ■	■	■	- / ■	■
Row connection only 6E, 7		3205	■		
Handle hole (n.w. back upholstery)	■	■	■	■	■
Castors, load-dependent braking				■	7826
2-D rocker mechanism lockable or 3-D rocker mechanism				■	
Partial foot ring				- / ■	
Elevation with foot ring 46-66 cm				8386.002	
Cross brace · size 5-7			■		



7802 CHANGE sliding chair PAGHOLZ® shell stained black-brown
7270 CHANGE school desk PAGHOLZ® board black brown stained

CHANGE SERIES | PAGHOLZ®



- PAGHOLZ® shell: resilient because it is scratch- and impact-resistant, break-proof and glow resistant, water resistant and flexible (info p. 159)
- different comfortable sitting positions when sitting invertedly
- filigree, robust chair frame made of 16/2 mm thick, chromed round tube with plastic floor protectors
- PAGHOLZ® seat shell and table top in PAGHOLZ® natural or color wood black-brown stained, see A2S material overview
- seat and back upholstery possible in fabric groups 1-4, see A2S material overview



Resistant to chemicals



Scratch- and wear-resistant



Shock- and break-proof



7270 5 tables stackable



7813 C-shape 5 chairs stackable



Standard incl. A2S piggyback equipment

Standard incl. A2S floorsafe® as standard

7813 CHANGE chair C-shape
7270 CHANGE School desk

CHANGE CHAIR



MODEL	7802	7813
Frame	Sliding chair	C-shape
Size	6	6
Weight	8 kg	4.3 kg
Stackability	5 pieces	5 pieces

OPTIONS

Chrome-plated frame	including	■
Powder-coated frame		including
A2S floorsafe®		including
Felt floor protectors	■	■
Upholstery seat/back	■	■
Row connection		■
Cross brace		■
Use	Training and seminar rooms Classrooms	Training and seminar rooms Classrooms

CHANGE SCHOOL DESK



MODEL	7270	7270.002
Frame	1-seater	1-seater
Size	6	6
Panel dimensions	70 x 55 cm	90 x 55 cm
Weight · size 6	18 kg	19 kg
Stackability	5 pieces	

OPTIONS

Chrome-plated frame	including	including
Felt floor protectors	■	■
Use	Training and seminar rooms Classrooms	Training and seminar rooms Classrooms





7100 WOODMARK sliding chair with C-shape frame
Scratch-resistant seat and back surface
available in many fresh colors



71 SERIES | MULTIPLEX/WOODMARK

- ideal for small rooms with little space, as no chair legs disturb when getting in and out
- extremely robust and durable due to the solid construction
- stable welded oval tube made of 2 mm thick steel, scratch-resistant because powder-coated
- scratch-resistant wood surface due to our unique WOODMARK melamine resin coating
- WOODMARK seat and back available in stained color wood, see A2S material overview
- seat and back upholstery possible in fabric groups 1-4, see A2S material overview

6100 | PLASTIC CHAIR

- seat and back made of polypropylene, recyclable
- ergonomically shaped with integrated ventilation channels
- seat and back available in red, blue and grey
- optional with felt floor protectors with kick protection
- in sizes 5 - 7
- frame in RAL 9006 chrome silver

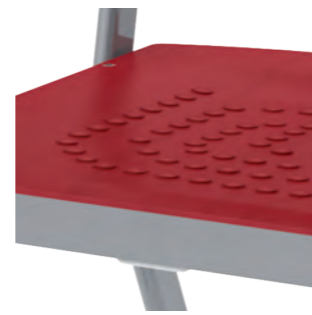

WOODMARK seat
with embossed nubs for
non-slip seating



Floor protectors
with kick protection



7100 WOODMARK C-shape
sliding chair,
5 chairs stackable



7130/7132 Sliding chair,
3-way height adjustable frame



7120 C-shape sliding chair
with writing surface



6100 Sliding chair
with seat and back made of plastic



8383 Gas-lift swivel chair







8382 Gas-lift swivel chair
with partial foot ring



8382.002 Gas-lift swivel chair
with foot ring

71 SERIES | MULTIPLEX/WOODMARK

					
MODEL	7110	7100	7130/7132	8342/8382	7950
Design	Multiplex seat without nubs	WOODMARK seat with nubs	WOODMARK seat with nubs	WOODMARK seat with nubs	WOODMARK seat with nubs
Powder-coated frame	C-shape	C-shape	height adjustable	Gas-lift I/II	Turning spindle
Powder-coated base				Aluminium	Steel
Size	2-7	2-7	3-5/5-7	3-5/5-7	5-7
Height adjustability			34-42/42-50 cm	31-42 cm/41-56 cm	41-59 cm
Weight · size 6	6.7 kg	6.7 kg	8 kg/11.3 kg	9 kg	8.8 kg
Stackability without upholstery · size 6	5 pieces	5 pieces	3/4 pieces		
OPTIONS					
Seat and back WOODMARK		including	including	including	including
Seat and back plastic	6100				
PAGHOLZ® color wood		■	■	■	■
Polished ALU frame				■	
Felt floor protectors	■	■	■	■	■
Upholstery seat/seat + back · size 6		7105/7106		8383/8384	
Row connection	■	■			
Castors, load-dependent braking				■	7960
Partial foot ring				- / ■	
Elevation with foot ring 50-70 cm				- /	8382.002
Writing surface · size 6-7		7120			



7470.003
Four-legged chair with seat and back upholstery



Also with seat upholstery up to 9 chairs vertically stackable due to stacking bar



Optional with panic-proof row connection; rows of chairs in rooms with more than 20 seats, e.g. also in the auditorium, must be linked according to §10/1 of the Assembly Rooms Ordinance

74 SERIES | MULTIPLEX SHELL

- vertically stackable up to 9 chairs
- micro-alloyed, 20/1.5 mm thick, chromed round steel tube
- solid beech multiplex shell, environmentally friendly varnished with water-based lacquer
- optional with trapezoidal grip hole on top
- shell Multiplex veneer direction longitudinal in color wood stained possible, see A2S material overview
- shell Multiplex veneer direction transverse with CPL-coating with especially scratch-resistant surface possible, but without grip hole, see A2S material overview
- on request with seat and back upholstery in fabric groups 1-4 possible, see A2S material overview



7470.003 Four-legged chair



7471.010 Four-legged chair with row connection, with CPL-coated pan



7470.004 Four-legged chair



7419.010 Cantilever chair



7429.011 Cantilever chair



8379 Gas-lift swivel chair

7470 SERIES | MULTIPLEX SHELL



MODEL	7470.003	7470.004	7470.010	7819.010	7419.010	7419.011	8379
Frame	4-legged	4-legged	4-legged	C-shape	Cantilever chair	Cantilever chair	Gas-lift
Size	6	6	6	6	6	6	5-7
Weight	5.4 kg	5.4 kg	6.7 kg	8.1 kg	6.5 kg	7.5 kg	7 kg
Stackability (also with upholstery)	9 pieces	9 pieces	9 pieces	5 pieces	5 pieces		

OPTIONS

Chrome-plated frame	including	including	including	■	including	including	Polished ALU
Powder-coated frame	■	■	■	including	■	■	including
Shell veneer direction	longitudinal	longitudinal	transverse	transverse	transverse		transverse
Shell color wood	■	■					
Shell CPL coating (without grip hole)			■	■	■		■
A2S floorsafe®				including			
Felt floor protectors	■	■	■	■	■	■	■
Seat upholstery	■	■	■	■	■	including	■
Back upholstery	■	■	■	■	■	including	■
Row connection	7471.003	7471.004	7471.010				
Armrests					7429.010	7429.011	
Handle hole (n. w. CPL/back upholstery)	■		■	■	■		■
Castors, load-dependent braking							■
3-D rocker mechanism							■
Partial foot ring							■
Elevation with foot ring 46-66 cm							8379.002
Cross brace				■			



7470.009
Beech multiplex shell round with four-legged frame in many attractive colors, optionally with kidney-shaped grip hole



7822 With seat and back upholstery



Up to 9 chairs stackable, also with upholstery

74 SERIES | MULTIPLEX SHELLROUND/WAISTED



- classic seat shell shapes for all applications
- made of solid beech multiplex, environmentally friendly varnished with water-based lacquer
- micro-alloyed, 20/1.5 mm thick, chromed round steel tube
- optional with kidney-shaped grip hole at the top for round shells and trapezoid-shaped shells with a waisted cut
- Multiplex shell in color wood stained possible, see A2S material overview
- on request with seat and back upholstery in fabric groups 1-4 possible, see A2S material overview



Optional with seat and back upholstery



7470.005
Beech multiplex shell, waisted and color wood stained with four-legged frame, optionally with trapezoidal grip hole



Up to 9 chairs stackable, also with upholstery

74 SERIES | MULTIPLEX ROUND SHELL



MODEL	7470.009	7822	8338/8378
Frame	4-legged	C-shape	Gas-lift I/II
Base			Aluminium
Size	6	2-7	3-5/5-7
Height adjustability			31-42 cm/41-56 cm
Weight · size 6	6.8 kg	8 kg	7 kg/8 kg
Stackability without upholstery · size 6	9 pieces	9 pieces	

MULTIPLEX WAISTED SHELL



MODEL	7470.005	7818	8337/8377
Frame	4-legged	C-shape	Gas-lift I/II
Base			Aluminium
Size	6	2-7	3-5/5-7
Height adjustability			31-42 cm/41-56 cm
Weight · size 6	5.4 kg	8 kg	7 kg/8 kg
Stackability without upholstery · size 6	9 pieces	9 pieces	

OPTIONS

Chrome-plated frame	including	■	- / Polished ALU	including	■	- / Polished ALU
Powder-coated frame	■	including	including		including	including
Shell veneer direction	longitudinal	longitudinal	longitudinal	longitudinal	longitudinal	longitudinal
Shell color wood	■	■	■	■	■	■
A2S floorsafe®		including			including	
Felt floor protectors	■	■	■	■	■	■
Seat upholstery size 6, 7	■	■	- / ■	■	■	- / ■
Back upholstery size 6, 7	■	■	- / ■	■	■	- / ■
Row connection	7471.009	■		7471.005	■	
Handle hole (n.w. back upholstery)	■ kidney shape	■ kidney shape	■ kidney shape	■ trapezoidal	■ trapezoidal	■ trapezoidal
Castors, load-dependent braking			■			■
2-D rocker mechanism lockable or 3-D rocker mechanism			■			- / ■
Partial foot ring			- / ■			- / ■
Elevation with foot ring 46-66 cm			8378.002			8377.002
Cross brace		■			■	





7097
Solid wood chair in sizes 2-6

7097 | SOLID WOOD CHAIR

- seat and back available in stained color wood, for color selection see A2S material overview
- optional with seat and back upholstery in fabric groups 1-4, see A2S material overview
- solid beech wood frame
- environmentally friendly sealed with water-based lacquer
- durable due to doweled, glued and screwed connections
- up to 6 chairs stackable



Solid beech wood;
environmentally friendly sealed
with water-based lacquer



Up to 5 chairs stackable



Softly rounded seat surface at
the front for comfortable sitting

52 SERIES | SOLID WOOD CHAIRS



- seat and back made of ergonomically shaped, solid beech multiplex
- frame made of solid beech wood, 55 x 30 mm thick
- environmentally friendly sealed with water-based lacquer
- optional with armrest made of solid beech wood
- optional seat and back in color wood stained possible, see A2S material overview
- without upholstery up to 6 chairs stackable
- seat and back upholstery possible in fabric groups 1-4, see A2S material overview

7000 | SOLID WOOD CHAIR



- robust two-column construction made of solid beech wood, mortised and doweled
- frame, seat and back environmentally friendly lacquered with water-based lacquer
- seat and back in beech multiplex optionally stained in color wood, see A2S material overview



Equipment for chair
suspension: protects the table
surface and the chair remains
securely on the table

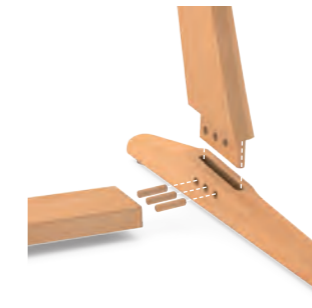

Durable due to mortised,
doweled and glued connections



Suitable combination:
7000 Solid wood chair
7010/7030 Solid wood table

7097 | SOLID WOOD CHAIR



MODEL	7097
Frame natural varnished beech	4-legged
Size	2-6
Weight · size 6	5.9 kg
Stackability without upholstery · size 6	6 pieces

52 SERIES | SOLID WOOD CHAIRS



MODEL	5261
Frame natural varnished beech	4-legged
Size	6
Weight · size 6	7.2 kg
Stackability without upholstery · size 6	6 pieces



MODEL	5271
Frame natural varnished beech	4-legged with armrests
Size	6
Weight · size 6	8.6 kg
Stackability without upholstery · size 6	5 pieces

7000 SOLID WOOD CHAIR



MODEL	7000
Frame natural varnished beech	Sliding chair
Size	2-7
Weight · size 6	5.8 kg

OPTIONS

Seat and back color wood	■
Felt floor protectors	■
Seat upholstery	■
Seat and back upholstery	■

Seat and back color wood	■
Felt floor protectors	■
Seat upholstery	■
Seat and back upholstery	■

Seat and back color wood	■
Felt floor protectors	■
Seat upholstery	■
Seat and back upholstery	■





9349.002 Office swivel chair with mesh back, with headrest and 3D armrests



9348.002 Office swivel chair with mesh back, with 3D armrests



9354.002 Office swivel chair with fabric back, with 3D armrests

PREMIUM OFFICE SWIVEL CHAIR



- synchronous, dynamic movement sequence permanently movable with locking of the back in 5 positions
- seat inclination and seat depth adjustment. Adjustable back 20°, seat 6° and seat depth adjustment range 6 cm
- black mesh back 56 cm high
- headrest black mesh 15 cm high and height adjustable by 7.5 cm
- independent adjustment of the lumbar support by membrane tension
- backrest with fabric cover 54 cm high
- models with upholstered seat and fabric back available with fabric groups 1-3, see A2S material overview
- models with upholstered seat and mesh back available with price groups 1-3, expect artificial leather, see A2S material overview
- optional with 3D armrests black, rotatable as well as height, width and depth adjustable
- gas-lift seat height adjustment incl. seat depth springing: 45-56 cm
- 5-arm base in die-cast aluminium, polished aluminium or RAL 9005 black with load-dependent braked safety castors



9352.002 Office swivel chair with mesh back and armrests



9353.002 Office swivel chair with fabric back with armrests

STANDARD OFFICE SWIVEL CHAIR

- synchronous mechanism with locking of the back in 4 positions
- seat inclination adjustment: Back 22°, seat 13°
- black mesh back 52 cm high
- backrest with fabric cover 54 cm high
- models with upholstered seat and fabric back available with fabric groups 1-3, see A2S material overview
- models with upholstered seat and mesh back available with price groups 1-3, expect artificial leather, see A2S material overview
- with lumbar support adjustment
- optional with armrests black
- gas-lift seat height adjustment 45-56 cm
- 5-arm base, black nylon with load-dependent braked safety castors

PREMIUM OFFICE SWIVEL CHAIR

STANDARD OFFICE SWIVEL CHAIR

					
MODEL	9349.001	9348.001	9354.001	9352.001	9353.001
Base	Polished ALU	Polished ALU	Polished ALU	Nylon black	Nylon black
Back	Mesh black*	Mesh black*	Fabric cover**	Mesh black*	Fabric cover**
Headrest	■	■	■	■	■
Lordosis adjustment	■	■	■	■	■
Height adjustability	45-56 cm	45-56 cm	45-56 cm	45-56 cm	45-56 cm
Dimensions W/H/D	66/116-135/63 cm	66/101-112/63 cm	66/97-118/61.5 cm	66/97-118/61.5 cm	66/97-118/61.5 cm
Weight	24 kg	23 kg	17 kg	15 kg	17 kg

OPTIONS

Base aluminium die-cast black	■	■	■	■	■
Armrests/3D armrests	- / 9349.002	- / 9348.002	- / 9354.002	9352.002 / -	9353.002 / -
Hard castors for soft floors	including	including	including	including	including
Soft castors for hard floors	■	■	■	■	■

* available with price groups 1-3, expect artificial leather

** non-upholstered back, structure like mesh back, but fabric-covered, available with fabric groups 1-3



9335 WAVE office swivel chair with wave-shaped seat and back upholstery



Resistant to chemicals



Scratch- and wear-resistant



Shock- and break-proof

WAVE SERIES CONFERENCE AND OFFICE SWIVEL CHAIR



- PAGHOLZ® shell: particularly slim design, therefore flexible and yet break-proof (info p. 159)
- PAGHOLZ® shell in PAGHOLZ® natural or color wood black-brown, see A2S material overview
- on request with flat or wave upholstery on seat and back, see A2S material overview
- infinitely variable height adjustment from 42-51 cm by gas-lift with depth spring
- synchronous mechanism with one-hand lever adjustment
- seat inclination mechanism with weight adjustment, inclination 0° - 18° lockable in 5 positions
- 5-legged, polished die-cast aluminium frame with load dependent braked safety double castors



7414 Cantilever chair



7424 Cantilever chair with armrests



7410 Four-legged chair



7410 Four-legged chair, 5 chairs stackable without upholstery

WAVE | CONFERENCE AND OFFICE SWIVEL CHAIR



MODEL	7410	7414	9335
Chrome-plated frame	4-legged	Cantilever chair	Gas-lift
Base			Polished ALU
Size	6	6	5-7
Height adjustability			42-56 cm
Weight	10 kg	10 kg	12.4 kg
Stackability without upholstery · size 6	5 pieces	5 pieces	

OPTIONS

	7424	
Armrests	■	■
Felt floor protectors	■	■
Wave upholstery on seat	■	■
Wave upholstery on back	■	■
Flat upholstery on seat	■	■
Flat upholstery on back	■	■





9251.002 Cantilever conference chair with mesh back and armrests

CONFERENCE CHAIR

- black mesh back, height 28 cm
- back fully upholstered, height 39 cm
- full upholstery in material groups 1-4 possible, see A2S material overview
- cantilever and four-legged frame in chrome-plated round tube, stackable
- frame optionally powder-coated in RAL 9006 chrome silver or RAL 9005 black
- optional with armrests



9252.002 Four-legged with mesh back and armrests



9253.002 Cantilever fully upholstery with armrests



9254.002 Four-legged chair fully upholstered with armrests

CONFERENCE CHAIR



MODEL	9251.001	9252.001	9253.001	9254.001	9250
Chrome-plated frame	Cantilever chair	4-legged	Cantilever chair	4-legged	for 4-legged model series 9252 and 9254
Back	Mesh	Mesh	Upholstery	Upholstery	
Seat height	46 cm	46 cm	46 cm	46 cm	5 kg
Dimensions W/H/D	53/83/57 cm	53/80/57 cm	53/86/57 cm	53/83/55 cm	4 pieces
Weight	6 kg	6 kg	8 kg	7 kg	
Stackability	4 pieces	4 pieces	4 pieces	4 pieces	

OPTIONS

Powder-coated frame	RAL 9006 chrome silver RAL 9005 black	RAL 9006 chrome silver RAL 9005 black	RAL 9006 chrome silver RAL 9005 black	RAL 9006 chrome silver RAL 9005 black
Felt floor protectors	■	■	■	■
Armrests	9251.002	9252.002	9253.002	9254.002
Dimensions with armrests W/H/D	60/83/57 cm	60/80/57 cm	60/86/57 cm	60/83/55 cm
Weight with armrests	7 kg	7 kg	9 kg	8 kg

STACKING TRANSPORTER



9374.002 Lounge chair 3-colored with 2D-rocker function

UPHOLSTERED/LOUNGE CHAIR

- 1- or 3-colored fabric cover possible in fabric groups 1-4, see A2S material overview
- upholstered gas-lift swivel chair with rocker mechanism incl. lock
- 5-arm base with load-dependently braked safety castors
- lounge chair wire frame with 2D rocker function
- four-legged frame in ash solid wood natural varnished



Fabric selectable in 3 colors within a fabric group



9376.001 Upholstered armchair 3-colored, solid ash wood



9370 Gas-lift swivel chair 3-colored with load dependent braked safety castors

UPHOLSTERED/LOUNGE CHAIR



MODEL	9370	9374.001	9374.002	9376.001
Frame	Gas-lift base Polished ALU	Wire frame RAL 9006 chrome silver RAL 9010 white RAL 9005 black	Wire frame RAL 9006 chrome silver RAL 9010 white RAL 9005 black	4-legged Ash solid wood
Seat height	48-58 cm	46 cm	46 cm	46 cm
2D rocker function		■	■	■
Dimensions W/H/D	69/82-95/63 cm	60/82/60 cm	60/74/62 cm	60/83/62 cm
Weight	14 kg	12 kg	12 kg	11 kg
Certification		GS Certificate	GS Certificate	GS Certificate

OPTIONS

Frame	RAL 9005 black	chrome-plated	chrome-plated	
Hard castors for soft floors	including			
Soft castors for hard floors	■			
Felt floor protectors		■	■	■



8389 Gas-lift swivel stool with load-dependent braked castors
PAGHOLZ®-seat natural

STOOL

PAGHOLZ®/MULTIPLEX

- PAGHOLZ®-seat: resilient, because it is scratch- and impact-resistant, break-proof and glow-resistant, water-resistant and flexible
- all frames are scratch-resistant powder-coated
- 4-legged stool optional with foot ring or foot rests at various heights, up to 15 pieces stackable
- turning spindle with continuously welded, 5-arm steel base with plastic floor protectors, infinitely variable in height
- gas-lift with stable, 5-legged base made of die-cast aluminium, infinitely height adjustable, optional with felt floor protectors or with load-dependent braked safety double castors
- on request seat in color wood stained possible, see A2S material overview

TURNING SPINDLE STOOL

- upholstery made of foam
- seat upholstery available in material groups 1-4, see A2S material overview
- ash frame legs solid wood natural varnished
- upper part of the frame powder-coated, optional in RAL 9005 black or RAL 9010 white
- height adjustment by means of turning spindle

PLASTIC STOOL

- plastic recyclable
- seat height adjustment by hand strap from 45-63 cm by safety gas-lift
- soft seat inlay and base in RAL 7012 basalt grey
- stable stand, as underside is slip-resistant
- available in the colors black, grey-white, red, lemon and pastel turquoise



Resistant to chemicals



Scratch- and wear-resistant



Shock- and break-proof



7984 PAGHOLZ® four-legged stools, stackable up to 15 pieces



7984.002 PAGHOLZ® four-legged stool with all-round foot ring, non-stackable



7984014/7984017 PAGHOLZ® four-legged stools with foot rests at different heights



7936 PAGHOLZ® Turning spindle stool





9377.001 Upholstered stool, solid ash wood frame



7940 Plastic stool with seat height adjustment

STOOL

						
MODEL	7984	7984014/7984017	8349/8389	7936	9377.001	7940
Frame	4-legged	4-legged	Gas-lift I/II	Turning spindle	4-legged wood	
Base			Aluminium	Steel		
Head office	PAGHOLZ®	PAGHOLZ®	PAGHOLZ®	PAGHOLZ®	upholstered	Plastic
Size	6	6	2-5/4-7	5-7	6	6
Height	46 cm, 50 cm, 55 cm	55 cm/46 cm	30-41/39-54 cm	40-58 cm	46-58 cm	45-58 cm
Weight	3.1 kg	4 kg/3.1 kg	4.2 kg/5 kg	6 kg	7 kg	4.3 kg
Stackability	15 pieces	9 pieces				

OPTIONS

Chrome-plated frame	■	■	Polished ALU		Oak	
Powder-coated frame	including	including	including	including	RAL 9005/9010	
Seat multiplex	■	■	■	■		
PAGHOLZ® color wood	■	■	■	■		
Felt floor protectors	■	■	■	■	■	
Castors, load-dependent braking			■	7935		
Foot ring	7984.002					
Various foot rests					2-5/2-4 +40 cm	



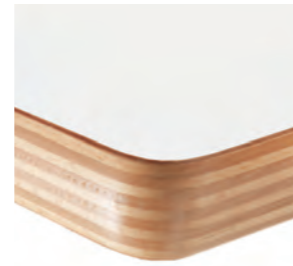

Solid beech multiplex edge crowned natural varnished



9445.160 Bench with castors

BENCHES

- seats made of solid beech multiplex or beech wood
- environmentally friendly sealed with water-based lacquer
- beech multiplex seat with HPL coating available in many finishes, see A2S material overview
- powder-coated frame in various colors, see A2S material overview
- stackable bench optional with castors ideal for flexible use



9459.004 Bench solid wood with middle bar



9440 Changing room bench double-sided



9430 Changing room bench one-sided



9445.100 Bench, stackable. Retrofittable with castors at any time



Stackable 5 pieces



With 2 castors on one side for easy changeover

BENCHES



MODEL	9459.004	9445.100	9430	9440	9450
Frame			one-sided	double-sided	
Powder-coated frame	Solid wood	■	■	■	■
Seat solid beech wood	Multiplex board	Multiplex board	■	■	■
Backrest			■	■	
Size/seat height	38 cm	3/4/5/6	42 cm	42 cm	42 cm
Lengths	1.20 m	1 m/1.20 m/1.60 m/1.80 m/2 m	1 m/2 m/3 m/4 m	1 m/2 m/3 m/4 m	1 m/2 m/3 m/4 m
Weight	9 kg	8.54 kg	30 kg	40 kg	20 kg
Stackability		5 pieces			

OPTIONS

Chrome-plated frame	■
Castors can be retrofitted	■
Felt floor protectors	■
Shoe tray	9460
With rear crossbar	9469.004



3639 CHANGE high table 2-seater
7897 CHANGE bench 2-seater
7898 CHANGE bench 1-seater

CHANGE | HIGH TABLE AND BENCHES

- filigree lounge furniture for comfortable sitting
- closed skid as subconstruction, made of chrome-plated, micro-alloyed round steel, each with plastic floor protectors, optional with felt floor protectors
- with stable cross braces as supports for the feet
- CHANGE series seat and table top in PAGHOLZ® natural or color wood black-brown
- barstool seat in CPL black coated

CHANGE HIGH TABLE AND BENCHES



MODEL	7897	7898	3639	7896
Frame	Bench 2-seater	Bench 1-seater	High table 130 x 65 cm	Bar stool
Seat/table top	PAGHOLZ®	PAGHOLZ®	PAGHOLZ®	Beech plywood
Height	88 cm	88 cm	118 cm	83 cm
Weight	14 kg	10 kg	18 kg	7 kg

OPTIONS

Chrome-plated frame	including	including	including	
Brushed stainless steel				including
Felt floor protectors	■	■	■	■



9378 High table
9377.002 Turning spindle stool

TURNING SPINDLE STOOL AND HIGH TABLE

- frame in solid wood ash or optional in natural lacquered oak
- upper part of the frame powder-coated in RAL 9005 black or RAL 9010 white
- table frame equipped with two bag hooks
- tabletop melamine coated white or optional in solid oak
- stool height adjustable by means of a turning spindle
- table and stool with foot ring in brushed stainless steel
- stool seat upholstered, fabric as desired 2-colored, see A2S material overview
- upholstery made of foam

TURNING SPINDLE STOOL AND HIGH TABLE



MODEL	9377.002	9378
Solid wood frame	Ash	Ash
Frame upper part powder-coated	■	■
Height	72-92 cm	110 cm
Table top Ø		60 cm
Table top finish		Pure white
Weight	9 kg	14 kg

OPTIONS

Solid wood frame	Oak	Oak
Table top natural oak		■
Felt floor protectors	■	■



Optional with integrated sockets

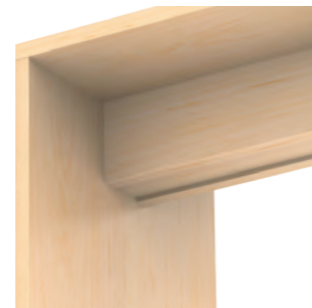

Integrated cable channel under the table top



Optional with floor mounting



3101.208 SOLID table
3103.194 SOLID bench
3104.194 Bench upholstery

31 SERIES | SOLID TABLES AND BENCHES

- made of 38 mm thick 3-layer finish board B1 according to DIN 4102
- 2 mm plastic edge in table top color
- available in three heights
- completely demountable system
- floor protectors with level compensation
- optional with floor mounting and integrated sockets incl. cable duct
- version with privacy screen available for high tables
- use: All-day rooms, assembly hall, cafeteria, canteen, hallway
- bench upholstery cover available with fabric groups 2-4, see A2S material overview



3101.208 SOLID table equipped with central sockets
7899 Bar stool



3112.208 SOLID table with privacy screen equipped with sockets at the front and lateral cable outlets

31 SERIES | SOLID TABLES

	64 CM AND 75 CM	WITH FOOTREST 110 CM	WITH BACK WALL 110 CM
HEIGHT			
Plate dimensions 120 x 80 cm	3101.128	3102.128	3112.128
Plate dimensions 140 x 80 cm	3101.148	3102.148	3112.148
Plate dimensions 160 x 80 cm	3101.168	3102.168	3112.168
Plate dimensions 180 x 80 cm	3101.188	3102.188	3112.188
Plate dimensions 200 x 80 cm	3101.208	3102.208	3112.208
Footrest		■	■
Privacy screen			■

OPTIONS

Cable outlet	■	■	■
Floor mounting	■	■	■
2-way power socket with USB charger*	■	■	■
2-way socket with network*	■	■	■

* 1 x central up to W 140 cm, 1 x left and 1 x right from W 160 cm

31 SERIES | SOLID BENCHES

	38 CM AND 45 CM	WITH FOOTREST 75 CM	BENCH UPHOLSTERY
SEAT HEIGHT			
Seat area 110 x 38 cm	3103.114	3105.114	3104.114
Seat area 130 x 38 cm	3103.134	3105.134	3104.134
Seat area 150 x 38 cm	3103.154	3105.154	3104.154
Seat area 170 x 38 cm	3103.174	3105.174	3104.174
Seat area 190 x 38 cm	3103.194	3105.194	3104.194

OPTIONS

Floor mounting	■	■	
----------------	---	---	--





A2S TABLE SERIES



Classroom tables 44 46 48 50 52 54



Height-adjustable tables 56 58 58 60 62



Teacher's desks 63 64 64 64 64



Specialist room tables 66 68



Folding tables 70 72 74 75 76



Table systems | Containers 78 82 86 92 92 94

Other table sizes, tabletop materials and all options for the tables shown can be found on the pages indicated. You will find our selection of colors, fabrics, finishes and materials in our A2S material overview.



7280 Four-legged classroom table with WOODMARK table top, Tidy Box and 2 castors optional



Easy to stack from the front also with book storage or Tidy Box



With piggyback equipment to prevent the table top from sliding down or scratching when tables are stacked



Optional with stable castors for easy movement in flexible teaching

7280 SERIES | CLASSROOM TABLES

- due to the unique asymmetrical frame, the tables are stackable and can be placed side by side without joints
- sturdy, yet lightweight round tube steel frame, scratch-resistant powder-coated or chrome-plated
- available in frame size 2-7
- working surfaces with multi-layer melamine resin coating, thus scratch-resistant, shock-proof and glare-free
- as standard we deliver the table with a 3 mm plastic edge in the color of the top, see A2S material overview
- other possible board designs: Edge beech concealed edge band crowned, ASSODUR®-Multiplex, WOODMARK or 12 mm compact board, color selection see A2S material overview
- optional with 2 castors on the long side, mobile and therefore flexibly adjustable



7280 Four-legged classroom table with WOODMARK table top
7416.035 Footrest chair FLEX with comfortable one-hand operation of the footrest - learning at eye level



Up to 4 tables stackable



7280.005 Four-legged classroom table 2-seater with WOODMARK table top, chrome frame, with Tidy Boxes

7280 SERIES | CLASSROOM TABLES



MODEL	7280	7280	7280.002	7280.005	7280.008
Powder-coated frame	1-seater	1-seater	1-seater	2-seater	2-seater
Size	2-7	2-7	2-7	2-7	2-7
Plate dimensions W x D	70 x 50 cm	70 x 55 cm	75 x 65 cm	130 x 50/55 cm	130 x 65 cm
Weight · size 6	14.5 kg	15 kg	16.5 kg	21 kg	25 kg
Stackability	4 pieces	4 pieces	4 pieces	4 pieces	4 pieces

OPTIONS

Chrome-plated frame	■	■	■	■	■
Felt floor protectors	■	■	■	■	■
2 castors on the long side*		■	■	- / ■	■
Book storage basket zinc-plated	■	■	■	■	■
Chair suspension	■	■	■	■	■
Bag hook	including	including	including	including	including
Guide rails with Tidy Box A4	■	■	■	■	■

*only available in combination with felt floor protectors



7530 Classroom table 1-seater, optional with chair suspension



Chair suspension under the table top optional



Easy side entry, ideal for small rooms



A2S floor protectors with kick plate protect the floor and table feet from scratches and are easy to change

75 SERIES | CLASSROOM TABLES



- absolutely robust, torsion-free oval tube steel frame (50 x 30 x 2 mm) scratch-resistant powder-coated with board support, for extra large boards with double web
- easy side entry, ideal for small rooms
- available in frame size 2-7
- working surfaces with multi-layer melamine resin coating, thus scratch-resistant, shock-proof and glare-free
- as standard we deliver the table with a 3 mm plastic edge in the color of the table top, see A2S material overview
- other possible board designs: Edge beech concealed edge band crowned, ASSODUR®-Multiplex, WOODMARK or 12 mm compact board, color selection see A2S material overview



7536 Classroom table, 2-seater with double column and 12 mm compact board
7854 FLEX C-shape chair

75 SERIES | CLASSROOM TABLES



MODEL	7530	7530	7532	7534	7534	7536	7538
Powder-coated frame	1-seater	1-seater	1-seater	2-seater	2-seater	2-seater	2-seater
Size	2-7	2-7	2-7	2-7	2-7	2-7	2-7
Plate dimensions W x D	70 x 50 cm	70 x 55 cm	75 x 65 cm	130 x 50 cm	130 x 55 cm	130 x 65 cm	150 x 65 cm
Weight · size 6	17 kg	17.5 kg	19 kg	23 kg	24 kg	26 kg	28 kg

OPTIONS

WOODMARK board	■	■	■	■	■	■	■
Book storage basket zinc-plated	■	■	■	■	■	■	■
Chair suspension	■	■	■	■	■	■	■
Felt floor protectors with kick plate	■	■	■	■	■	■	■
Bag hook	including	including	including	including	including	including	including
Guide rails with Tidy Box A4	7530003	7530003	■	■	■	■	■



9530 Classroom table 1-seater with Tidy Box A4



In the Tidy Box, even small utensils such as erasers or rulers are in good hands.



The Tidy Box with exchangeable name badge is available in 2 sizes and in 5 colors, see A2S material overview







95 SERIES | CLASSROOM TABLES

- robust, torsion-free double-column construction (40 x 20 x 1.5 mm and 50 x 30 x 2 mm) scratch-resistant powder-coated, with board support for 2-seater, selection of steel colors see A2S material overview
- available in frame size 2-7
- working surfaces with multi-layer melamine resin coating, thus scratch-resistant, shock-proof and glare-free
- as standard we deliver the table with a 3 mm plastic edge in the color of the top, see A2S material overview
- other possible board designs: Edge beech concealed edge band crowned, ASSODUR®, Multiplex, WOODMARK or 12 mm compact board, color selection see A2S material overview



9534 Classroom table 2-seater with chair suspensions in WOODMARK maple finish
7100 WOODMARK sliding chair in maple finish

95 SERIES | CLASSROOM TABLES

							
MODEL	9530	9530	9532	9534	9534	9536	9538
Powder-coated frame	1-seater	1-seater	1-seater	2-seater	2-seater	2-seater	2-seater
Size	2-7	2-7	2-7	2-7	2-7	2-7	2-7
Plate dimensions W x D	70 x 50 cm	70 x 55 cm	75 x 65 cm	130 x 50 cm	130 x 55 cm	130 x 65 cm	150 x 65 cm
Weight · size 6	13 kg	13.5 kg	15 kg	18.5 kg	19.5 kg	20 kg	21.5 kg

OPTIONS

WOODMARK board	■	■	■	■	■	■	■
Book storage basket zinc-plated	■	■	■	■	■	■	■
Chair suspension	■	■	■	■	■	■	■
Bag hook	including	including	including	including	including	including	including
Guide rails with small Tidy Box A4	■	■	■	■	■	■	■
Felt floor protectors	■	■	■	■	■	■	■



7010 Solid wood sliding table, 1-seater with bag hook
7000 Solid wood sliding table



7030 Wooden sliding table, 2-seater, solid wood, environmentally friendly protected with water-based lacquer

70 SERIES | CLASSROOM TABLES

- solid beech frame from sustainable forestry, environmentally friendly varnished with water-based lacquer
- extra stable with continuously mortised and glued connections
- available in frame size 2-7
- working surfaces with multi-layer melamine resin coating, thus scratch-resistant, shock-proof and glare-free
- as standard we deliver the table with a 3 mm plastic edge in the color of the top, see A2S material overview
- other possible board designs: Edge beech concealed edge band crowned, ASSODUR®, Multiplex, WOODMARK or 12 mm compact board, color selection see A2S material overview

70 SERIES | CLASSROOM TABLES



MODEL	7010	7010	7030	7030
Frame natural beech, varnished	1-seater	1-seater	2-seater	2-seater
Size	2-7	2-7	2-7	2-7
Plate dimensions W x D	70 x 50 cm	70 x 55 cm	130 x 50 cm	130 x 55 cm
Weight · size 6	11 kg	11.5 kg	18 kg	20 kg

OPTIONS

Book storage basket zinc-plated	■	■	■	■
Felt floor protectors	■	■	■	■
Bag hook	■	■	■	■





7220 Classroom table 2-seater
optional with chair suspension
7307 PAGHOLZ® C-shape sliding chair



7210 1-seater with WOODMARK board
7853 FLEX Z-shape

72/73 SERIES | CLASSROOM TABLES

- absolutely robust round tube steel frame (30 x 2 mm), scratch-resistant powder-coated or chrome-plated, with board support for 2-seater
- available in frame size 2-7
- working surfaces with multi-layer melamine resin coating, thus scratch-resistant, shock-proof and glare-free
- as standard we deliver the table with a 3 mm plastic edge in the color of the top, see A2S material overview
- other possible board designs: Edge beech concealed edge band crowned, ASSODUR®, Multiplex, WOODMARK or 12 mm compact board, color selection see A2S material overview

72/73 SERIES | CLASSROOM TABLES



MODEL	7210	7210	7310	7220	7220	7320	7340
Powder-coated frame	1-seater	1-seater	1-seater	2-seater	2-seater	2-seater	2-seater
Size	2-7	2-7	2-7	2-7	2-7	2-7	2-7
Plate dimensions W x D	70 x 50 cm	70 x 55 cm	75 x 65 cm	130 x 50 cm	130 x 55 cm	130 x 65 cm	150 x 65 cm
Weight · size 6	8.5 kg	9 kg	12 kg	15 kg	16 kg	18 kg	20 kg

OPTIONS

WOODMARK board	■	■	■	■	■	■	■
Book storage basket zinc-plated*	■	■	■	■	■	■	■
Chair suspension*	■	■	■	■	■	■	■
Bag hook	including	including	including	including	including	including	including
Felt floor protectors	■	■	■	■	■	■	■

*either book storage basket or chair suspension





8564 Classroom table 2-seater with WOODMARK board, optional with chair suspension
7811 PAGHOLZ® C-shape with handle hole



Easy cleaning of table top and floor due to chair suspension



856 Series
 can be seated from both sides - ideal for group work



A2S floor protectors protect floor and table feet from scratching

856 SERIES CLASSROOM TABLES FIXED AND HEIGHT-ADJUSTABLE



- robust, torsion-free oval column construction (50 x 30 x 2 mm), scratch-resistant powder-coated, with crossbar (50 x 20 x 2 mm) and board support for 2-seater
- available in fixed frame sizes 2-7
- height-adjustable models with grid height adjustment by means of screw connection for sizes 3-6 and 4-7
- for further height-adjustable classroom tables see page 56
- incl. A2S floor protectors, protect the floor and table feet from scratches
- working surfaces with multi-layer melamine resin coating, thus scratch-resistant, shock-proof and glare-free
- as standard we deliver the table with a 3 mm plastic edge in the color of the top, see A2S material overview
- other possible board designs: Edge beech concealed edge band crowned, ASSODUR®, Multiplex, WOODMARK or 12 mm compact board, color selection see A2S material overview



8580.135 Classroom table 2-seater with grid height adjustment and book storage basket



Multiple height adjustments with allen key



Optional with book storage basket



Including bag hook on the right or on both sides for 2-seater

856 SERIES | CLASSROOM TABLES



MODEL	8560	8562	8564	8566	8567
Powder-coated frame	1-seater	1-seater	2-seater	2-seater	2-seater
Size	2-7	2-7	2-7	2-7	2-7
Plate dimensions W x D	70 x 50/55 cm	75 x 65 cm	130 x 50/55 cm	130 x 65 cm	150 x 65 cm
Weight · size 6	12.5 kg	14 kg	19 kg/20 kg	20 kg	22 kg
Height-adjustable · size 3-6	8581.075	8581.076	8581.135		
Height adjustable · size 4-7	8580.075	8580.076	8580.135		

OPTIONS

WOODMARK board	■	■	■	■	
Book storage basket zinc-plated*	■	■	■	■	■
Chair suspension*	■	■	■	■	■
Bag hook	including	including	including	including	including
Felt floor protectors	■	■	■	■	■

*either book storage basket or chair suspension



Solid beech multiplex edge crowned natural varnished

7750 Classroom table 1-seater height-adjustable
Multiplex top, edges natural varnished, optional with chair suspension
7130/7132 WOODMARK sliding chair height-adjustable in sizes 3-5/5-7

77 SERIES HEIGHT-ADJUSTABLE CLASSROOM TABLES



- robust metal frame, scratch-resistant due to powder coating, selection of colors see A2S material overview
- easy locking by grid height adjustment with snap lock and safety shut-off by Allen screw
- available in the 2 frame sizes 2-5 and 5-7
- incl. bag hook on the right or on both sides for 2-seater
- working surfaces with multi-layer melamine resin coating, therefore scratch-resistant, shock-proof and glare-free
- as standard we deliver the table with a 3 mm plastic edge in the color of the top, see A2S material overview
- other possible board designs: Edge beech concealed edge band crowned, ASSODUR®, Multiplex, WOODMARK or 12 mm compact board, color selection see A2S material overview



Multiple height adjustment, in sizes 2-5 or 5-7, with colored size labelings

7755 Classroom table 2-seater height-adjustable with WOODMARK board, optional with Tidy Boxes A4



Multiple height adjustments with allen key

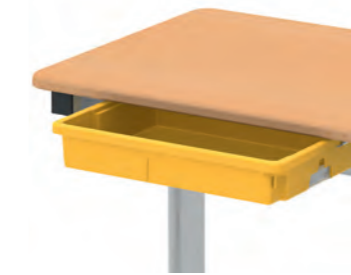



Tidy Boxes create order and more space on the work surface



A2S floor protectors with kick plate protect the floor and table feet from scratches and are easy to change

77 SERIES | HEIGHT-ADJUSTABLE CLASSROOM TABLES

				
MODEL	7750	7760	7755	7765
Powder-coated frame	1-seater	1-seater	2-seater	2-seater
Size	2-5/5-7	2-5/5-7	2-5/5-7	2-5/5-7
Height adjustability	54-70/70-82 cm	54-70/70-82 cm	54-70/70-82 cm	54-70/70-82 cm
Plate dimensions W x D	70 x 55 cm	75 x 65 cm	130 x 55 cm	130 x 65 cm
Weight	18 kg/18.5 kg	19.5 kg/20.5 kg	22.5 kg/23.5 kg	24.5 kg/25.5 kg

OPTIONS				
Book storage basket zinc-plated	■	■	■	■
Chair suspension	■	■	■	■
Felt floor protector with kick plate	■	■	■	■
Bag hook	including	including	including	including
Guide rails with Tidy Box A4	■	■	■	■



Bag hook on the right or on both sides for 2-seater

Infinitely variable in height by means of manually operated spindle gear with colored size labelings

7692 Classroom table 1-seater height-adjustable, with fixed table top
8389 PAGHOLZ® gas lift swivel stool

Feet with scratch protection and adjusting screws to level uneven floors

76 SERIES HEIGHT-ADJUSTABLE CLASSROOM TABLES



- robust metal frame, scratch-resistant due to powder coating, selection of colors see A2S material overview
- adjustable from size 3-7
- incl. A2S floor protectors with kick plate, protect the floor and table feet from scratches and are easy to change
- working surfaces with multi-layer melamine resin coating, thus scratch-resistant, shock-proof and glare-free
- as standard we deliver the table with a 3 mm plastic edge in the color of the table top, see A2S material overview
- other possible board designs: Edge beech concealed edge band crowned, ASSODUR®, Multiplex, WOODMARK or 12 mm compact board, color selection see A2S material overview



ACCESSORIES FOR CLASSROOM TABLES

CHAIR SUSPENSIONS



0200
suitable for chair models **7200/7205/7800/7805** PAGHOLZ® sliding chair



0831
Zinc-plated steel with rubber coating suitable for chair models **7100** WOODMARK ssliding chair (size 3-7) **7307/7811/7813** PAGHOLZ® C-shape **7819.010/7822** Multiplex C-shape



0837
suitable for chair models **8385** PAGHOLZ® gas lift swivel chair **7854** FLEX C-shape **7873** FLEX gas lift swivel chair **7875** FLEX swivel chair



0881*/0882*
suitable for chair models **7873** FLEX gas lift swivel chair 3D rocker (size 5-7)/ **7876** FLEX gas lift swivel chair 3D rocker (size 3-5)

* Only suitable for tables without front frame

BOOK STORAGE BASKET



0303/0304
50 x 8.5 x 20 cm, zinc-plated

TIDY BOXES



0886
31 x 7,5 x 43 cm, in 5 colors

BAG HOOK



0540
galvanized

1110 | DRAWING TABLE



1110 Drawing table with storage, optional with book stop

1110 Drawing table with continuously tiltable and height-adjustable table top, board version exclusively in 3-layer finish board (E1), 0.8 mm glued with 2 mm plastic edge, for finish selection see A2S material overview

76 SERIES | HEIGHT-ADJUSTABLE CLASSROOM TABLES WITH STRAIGHT BOARD



MODEL	7692	7697
Powder-coated frame	1-seater	2-seater
Size	3-7	3-7
Height adjustability	58-82 cm*	58-82 cm*
Board inclination		
Plate dimensions W x D	75 x 65 cm	130 x 65 cm
Weight · size 6	25 kg	40 kg

OPTIONS

Book storage basket zinc-plated	■	■
Felt floor protectors with kick plate	■	■
Book stop		■
Removable crank	■	■

*The crank for height adjustment is fixed as standard, but can also be supplied with a removable crank on request.

1110 | DRAWING TABLE



MODEL	1110
1-seater	76 cm
Board inclination	0-90 degrees
Plate dimensions W x D	90 x 60 cm
Weight	28 kg



5580.168 OFFICE desk electrically height adjustable



Self-explanatory control element optional with memory function



Hidden cable management by hinged cable tray



Easy levelling of uneven floors

OFFICE SERIES MOTORIZED HEIGHT-ADJUSTABLE OFFICE TABLES

- large adjustment range from 63 to 127 cm in height, therefore usable as a worktable and standing table
- stable frame even in standing height
- frame powder-coated in RAL 9006 chrome silver, RAL 9003 white or RAL 9005 black possible
- equipped with floor levellers
- hidden cable management by hinged metal cable tray incl. 6-way socket strip
- self-explanatory control element, optional with memory function
- note: Power supply required
- working surfaces with multi-layer melamine resin coating, therefore scratch-resistant, shock-proof and glare-free, for finishes see A2S material overview
- with a 3 mm plastic edge in board color, see A2S material overview



5580.168 OFFICE table
9232.800 Rolling container
7873.002 FLEX gas lift swivel chair with elevation and foot ring



5585.208 OFFICE table L-shaped
9335 WAVE gas lift swivel chair

OFFICE SERIES | MOTORIZED HEIGHT-ADJUSTABLE OFFICE TABLES RECTANGULAR

	■	■	■	■	■	■	■	■
MODEL	5580.148	5580.149	5580.168	5580.169	5580.188	5580.189	5580.208	5580.209
Frame powder-coated RAL 9006	■	■	■	■	■	■	■	■
motorized height-adjustability	63-127 cm	63-127 cm	63-127 cm	63-127 cm	63-127 cm	63-127 cm	63-127 cm	63-127 cm
Plate dimensions W x D in cm	140 x 80	140 x 90	160 x 80	160 x 90	180 x 80	180 x 90	200 x 80	200 x 90
Weight	36 kg	38 kg	41 kg	43 kg	44 kg	47 kg	48 kg	52 kg
6-way Schuko power socket with 3 m supply cable	■	■	■	■	■	■	■	■

OPTIONS

Frame black or white	■	■	■	■	■	■	■	■
Cable outlet	■	■	■	■	■	■	■	■
CPU holder 1876.020	■	■	■	■	■	■	■	■
Front panel	2050.142	2050.142	2050.162	2050.162	2050.182	2050.182	2050.202	2050.202

OFFICE SERIES | MOTORIZED HEIGHT-ADJUSTABLE OFFICE TABLES L-SHAPE

	■	■
MODEL	5585.208	5586.208
Variant	right	left
Powder-coated frame	■	■
motorized height-adjustability	63-127 cm	63-127 cm
Plate dimensions W x D in cm	200 x 160/80	200 x 160/80
Weight	86 kg	86 kg
6-way Schuko power socket with 3 m supply cable	■	■

OPTIONS

Frame black or white	■	■
Cable outlet	■	■
CPU holder 1876.020	■	■
Front panel	2050.202	2050.202

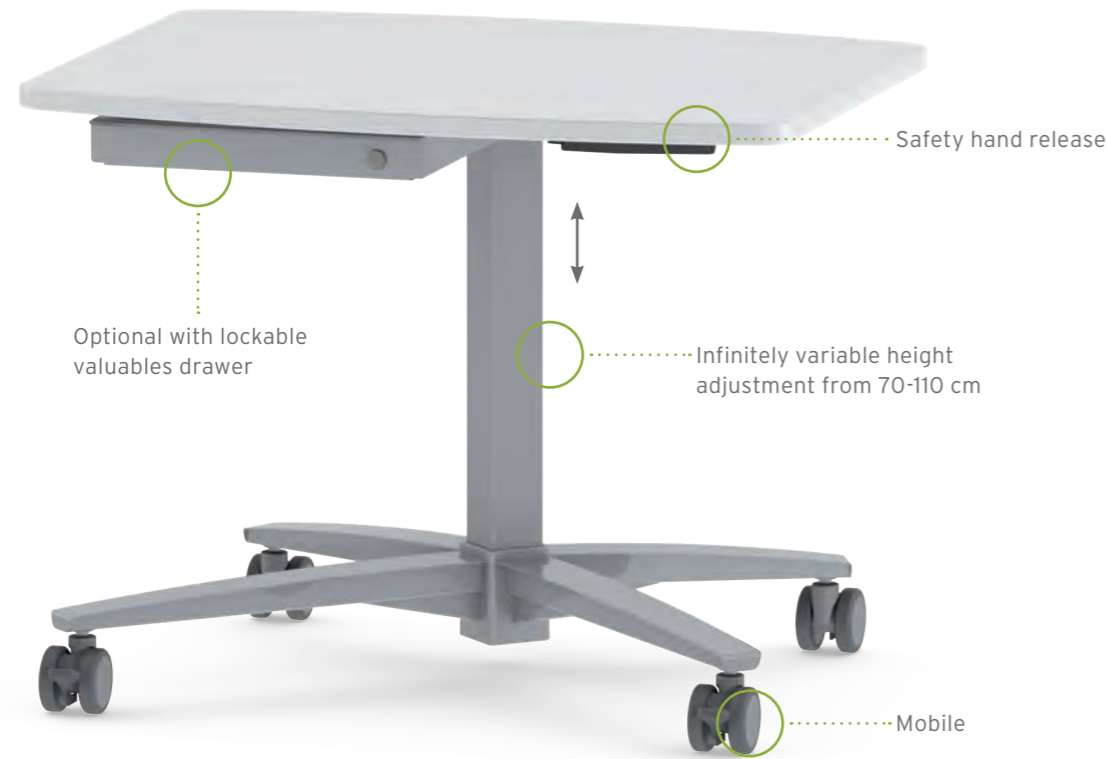

7616.097 Barrel-shaped mono-column table, mobile with lockable valuables drawer

76 SERIES HEIGHT-ADJUSTABLE MONO-COLUMN TABLES



- large adjustment range from 70 - 110 cm height, therefore usable as work and standing table
- triggering of the height adjustment by means of encapsulated Bowden cable and safety hand release, which prevents unintentional release
- heavy-duty, torsion-resistant tubular steel table column
- optional all-steel valuables drawer under the table top
- frame powder-coated in RAL 9006 chrome silver
- optionally available with 12 mm compact board, not with front panel
- possible finish table tops see A2S material overview



7612.076 Rectangular mono-column table with 12 mm compact board, with H-shaped frame, 2 floor protectors with levelling at the front and 2 castors at the back



7614.097 Barrel-shaped mono-column table with H-shaped frame, 2 floor protectors with levelling at the front and 2 castors at the back







7618.080 Circular mono-column table 5-legged base frame with robust easy-running castors



7620.138 Oval mono-column table with perforated sheet metal front panel
7873.002 FLEX gas lift swivel chair with foot ring

76 SERIES | PNEUMATIC HEIGHT-ADJUSTABLE MONO-COLUMN TABLES

BOARD					
MODEL	7612.076	7614.097	7615.138	7616.097	7618.080
Frame powder-coated RAL 9006	■	■	■	■	Polished ALU
Height adjustability	70-110 cm	70-110 cm	70-110 cm	70-110 cm	77-116 cm
Plate dimensions W x D	75 x 65 cm	90 x 70 cm	130 x 80 cm	90 x 70 cm	Ø 80 cm
Weight	19 kg	21.7 kg	31 kg/31.5 kg	19.1 kg	17.6 kg
Castors	■	■	■	■	■
OPTIONS					
Lockable valuables drawer			■	■	
Front panel			7620.138*		

*not possible with compact board



7268
Chrome-plated metal frame with two castors and a lockable base cabinet with two drawers

TEACHER'S DESKS

- frames match the classroom tables: made of metal, scratch-resistant powder-coated, or solid wood natural beech varnished with transparent water-based lacquer
- model 7268 mobile with castors (suitable for classroom table model 7280)
- optional with felt floor protectors
- the base units and drawers are lockable as standard
- working surfaces 130 x 65 cm or 150 x 65 cm with additional melamine resin coating, therefore scratch and impact resistant and glare-free
- as standard, we supply the table with a 3 mm plastic edge in the color of the table top, for color selection see A2S material overview
- WOODMARK board not possible in size 150 x 65 cm
- other possible board designs: Edge beech concealed edge band crowned, ASSODUR®, Multiplex, WOODMARK or 12 mm compact board, color selection see A2S material overview



7573.901 Base unit with storage compartment, with 1-door base unit on the right
Frame 4-legged oval tube



7357.902 Base unit with storage compartment, right base unit with utensil drawer and 3 drawers
Skid frame



7524.901 Base unit with storage compartment, with 1-door base unit and drawer on the left
Frame C-shape oval tube



7059.902 Base unit with storage compartment, left with 1-door base unit, right with utensil drawer and 3 drawers
Frame solid wood beech natural varnished

TEACHER'S DESKS BOARD SIZE 130 X 65 CM



FRAME	7571.901	7572.901/7573.901	7574.901/7575.901	7576.901/7577.901	7268**
4-legged*					
C-shape*	7521.901	7522.901/7523.901	7524.901/7525.901	7526.901/7527.901	
Skid**	7351.901	7352.901/7353.901	7354.901/7355.901	7356.901/7357.901	
Solid beech wood	7051.901	7052.901/7053.901	7054.901/7055.901	7056.901/7057.901	
Cabinet		left/right	left/right	left/right	left or right
Dimensions W/D/H in cm	130 x 65 x 76	130 x 65 x 76	130 x 65 x 76	130 x 65 x 76	130 x 65 x 76
Weight	46.3 kg	54 kg	58 kg	65 kg	54 kg

*powder-coated **powder-coated; chrome-plated frame optionally available

TEACHER'S DESKS BOARD SIZE 150 X 65 CM



FRAME	7571.902	7572.902/7573.902	7574.902/7575.902	7576.902/7577.902	7578.902	7579.902
4-legged**						
C-shape*	7521.902	7522.902/7523.902	7524.902/7525.902	7526.902/7527.902	7528.902	7529.902
Skid**	7351.902	7352.902/7353.902	7354.902/7355.902	7356.902/7357.902	7358.902	7359.902
Solid beech wood	7051.902	7052.902/7053.902	7054.902/7055.902	7056.902/7057.902	7060.902	7059.902
Cabinet		left/right	left/right	left/right	on both sides	on both sides
Dimensions W/D/H in cm	150 x 65 x 76	150 x 65 x 76	150 x 65 x 76	150 x 65 x 76	150 x 65 x 76	150 x 65 x 76
Weight	51 kg	58 kg	62 kg	69 kg	69 kg	81 kg

*powder-coated **powder-coated; chrome-plated frame optionally available



1810.168 Computer table 2-seater, upstand at the back of the table top, optional with CPU holder
7873 FLEX gas lift swivel chair with load-dependent braked castors

18 SERIES | COMPUTER TABLES

- absolutely stable, solid welded metal frame with scratch-resistant powder coating, color selection see A2S material overview
- 25 mm thick working surfaces with multi-layer melamine resin coating, therefore scratch-resistant, shock-proof and glare-free
- lockable board on slide fitting slides forward with lip seal at the back
- as standard, we supply the table with a 3 mm plastic edge in the color of the table top, for color selection see A2S material overview
- with installation channel for sockets, on request without upstand at the back
- frame is prepared to accommodate various attachments (see options)
- incl. A2S floor protectors, protect the floor and the table frame from scratches and are easy to change



1810.168 Board on slide fitting slides forward for easy, hidden cable entry, sealed with rubber lip



18 SERIES COMPUTER TABLES	80 CM DEEP				70 CM DEEP			
------------------------------	------------	--	--	--	------------	--	--	--

MODEL	1812.088	1811.128	1811.148	1810.168	1812.087	1811.127	1811.147	1810.167
Powder-coated frame	1-seater	1-seater	2-seater	2-seater	1-seater	1-seater	2-seater	2-seater
Height	72 cm	72 cm	72 cm	72 cm	72 cm	72 cm	72 cm	72 cm
Plate dimensions W x D	80 x 80 cm	120 x 80 cm	140 x 80 cm	160 x 80 cm	80 x 70 cm	120 x 70 cm	140 x 70 cm	160 x 70 cm
Weight	30.5 kg	55 kg	57 kg	60 kg	39 kg	53 kg	55 kg	57 kg

OPTIONS	1812.088	1811.128	1811.148	1810.168	1812.087	1811.127	1811.147	1810.167
CPU holder		■	■	■		■	■	■
CPU cabinet open		■	■	■				
CPU cabinet with door		■	■	■				
Connecting fitting for 2 tables	■	■	■	■	■	■	■	■
Connecting fitting for 2 tables with 1 corner element	■	■	■	■	■	■	■	■
Cable channel	■	■	■	■	■	■	■	■
Floor mounting	■	■	■	■	■	■	■	■
Floor leveller	■	■	■	■	■	■	■	■
6-way Schuko power socket with 3 m supply cable	■	■	■	■	■	■	■	■
Felt floor protectors with kick plate	■	■	■	■	■	■	■	■





3930 Series
folding tables in 2 heights: 72 and 75 cm



Robust mechanics,
easy to fold up

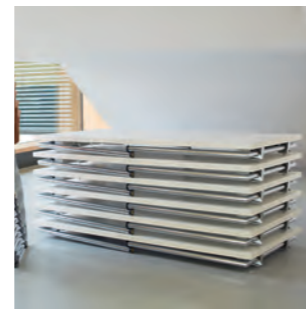

Easily stackable up to 16 tables
thanks to hard rubber buffer



Suitable stacking trolley for safe and
convenient transport of up to 10 tables,
powder-coated RAL 9006 chrome silver

3930 SERIES | FOLDING TABLES

- seating at all four sides
- stable 4-legged folding frame made of round tube (40 x 2 mm), scratch-resistant powder-coated or chrome-plated
- easily stackable up to 16 tables thanks to hard rubber buffer
- equipped with an aluminium design frame (Fig. p. 72), laterally beveled in natural anodised finish
- optional with recessed solid wood frame and rounded corners - conceals the folding mechanism
- plastic floor protectors with level compensation
- working surfaces with multi-layer melamine resin coating, thus scratch-resistant, shock-proof and glare-free
- as standard we deliver the table with a 3 mm plastic edge in the color of the top,
for finish selection see A2S material overview
- optional with robust ASSODUR®-edge or solid wood edge, concealed edge band crowned and natural lacquered
- glued chipboard from a width of 160 cm with aluminium frame



3930 Series allows four-sided seating,
flexible arrangement in row or in group possible
7813 CHANGE C-shape chair

3930 SERIES FOLDING TABLES	120 CM	140 CM	160 CM	180 CM						
MODEL	3930.126	3930.127	3930.128	3930.147	3930.148	3930.167	3930.168	3930.187	3930.188	3930.189
Powder-coated frame	■	■	■	■	■	■	■	■	■	■
Height in cm	72/75	72/75	72/75	72/75	72/75	72/75	72/75	72/75	72/75	72/75
Dimensions W x D in cm	120 x 60	120 x 70	120 x 80	140 x 70	140 x 80	160 x 70	160 x 80	180 x 70	180 x 80	180 x 90
Weight with aluminium frame	24.3 kg/ 24.8 kg	26.9 kg/ 27.4 kg	29.2 kg/ 29.7 kg	29.9 kg/ 30.4 kg	32 kg/ 32.5 kg	33.4 kg/ 33.9 kg	34.9 kg/ 35.4 kg	34.4 kg/ 34.9 kg	37.7 kg/ 38.2 kg	40.8 kg/ 41.3 kg
OPTIONS										
ASSODUR® edge	■	■	■	■	■	■	■	■	■	■
Chrome frame	■	■	■	■	■	■	■	■	■	■
Recessed solid wood frame with rounded corners	■	■	■	■	■	■	■	■	■	■
Felt floor protectors	■	■	■	■	■	■	■	■	■	■
Stacking trolley 3899.147 (up to 160 cm)	■	■	■	■	■	■	■			
Stacking trolley 3899.187 (170-180 cm)								■	■	■



2010 Hexagonal corner unit combined with two **2001** Rectangular tables

Side and front panels are available in various colors and designs. Ask your A2S area manager.

Office chairs: Info p. 30

Containers: Info p. 92

2000 SERIES | DEMOUNTABLE METAL DESK SYSTEM



- demountable, absolutely robust metal frame, scratch-resistant powder-coated or chrome-plated
- directly coated side panels made of round tube (40 x 2 mm), frames made of square tube (40 x 20 x 2 mm)
- 25 mm thick, directly coated chipboard in a particularly scratch-resistant and shock-proof design
- as standard we deliver the table with a 3 mm plastic edge in the color of the top, for finish selection see A2S material overview
- different table top sizes and shapes (info p. 80-81)
- rectangular table tops optional with 40 mm corner radius
- optional 10 cm height-adjustable
- many accessories, e.g. CPU holder or cable channels (info p. 89)
- plastic floor protectors with level compensation
- for your individually planned table combination, please contact your A2S area manager
- available in two different table heights: 72 and 75 cm



TABLE COMBINATIONS

Do you manage extensive paper documents which need to be permanently available, do you make a lot of phone calls or have frequent meetings at your workplace? A2S offers the right solution for every work area to you - your A2S area manager will be happy to advise you.

EXAMPLES:



Single workstation as corner combination for smaller rooms

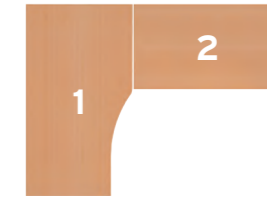

Consisting of
Table 1: **2031/2er** 90° extension table
Table 2: **2001s** rectangular table



Generous individual workstation with recessed connecting frames for more legroom

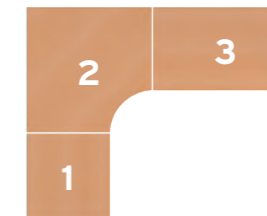

Consisting of
Table 1: **2001s** rectangular table
Table 2: **2011s** pentagonal table
Table 3: **2001s** rectangular table



Two workstations opposite each other with corner unit as visitor's seat or additional storage

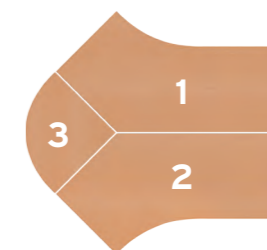

Consisting of
Table 1: **2030/28s** 45° extension table right
Table 2: **2029/27s** 45° extension table left
Table 3: **2016.080** rounded corner unit or **2017.080** straight corner plate

You will find further table combinations and tabletop variants on the following pages.

INDIVIDUALLY CONFIGURED TABLES

With variable frames, different table top shapes and extensive accessories, such as table attachments or panels, we can plan your workplace to suit your individual needs. Contact your A2S area manager.

	60 CM DEEP			70 CM DEEP				
MODEL	2001.066*	2001.106	2001.126	2001.077	2001.107	2001.127	2001.147	2001.167
Dimensions in cm	60 x 60	100 x 60	120 x 60	70 x 70	100 x 70	120 x 70	140 x 70	160 x 70
Weight H 72/75 cm	11.5 kg/12 kg	17.5 kg/18 kg	20.5 kg/21 kg	14.5 kg/15 kg	19.5 kg/20 kg	24.5 kg/25 kg	27.5 kg/28 kg	31 kg/32 kg

* ATTENTION: Consider the width of the chair frame!

	80 CM DEEP							
MODEL	2001.088	2001.108	2001.128	2001.148	2001.168	2001.188	2001.208	
Dimensions in cm	80 x 80	100 x 80	120 x 80	140 x 80	160 x 80	180 x 80	200 x 80	
Weight H 72/75 cm	17.5 kg/18 kg	22.5 kg/23 kg	26.5 kg/27 kg	28.5 kg/29 kg	32.5 kg/33 kg	37.5 kg/38 kg	39.5 kg/40 kg	

	90 CM DEEP							100 CM DEEP	
MODEL	2001.099	2001.109	2001.129	2001.149	2001.169	2001.189	2001.209	2001.100	2001.200
Dimensions in cm	90 x 90	100 x 90	120 x 90	140 x 90	160 x 90	180 x 90	200 x 90	100 x 100	200 x 100
Weight H 72/75 cm	20.5/21 kg	24.5/25 kg	28.5/29 kg	32.5/33 kg	40.5/41 kg	44.5/45 kg	47.5/48 kg	23.5/24 kg	49.5/50 kg

	90° EXTENSION		90° CORNER EXTENSION		45° EXTENSION		CIRCULAR EXTENSION	
MODEL	2031.188	2031.208	2033.188	2033.208	2029.228	2029.248	2035.228	2035.248
Dimensions in cm	180 x 80/100 left	200 x 80/100 left	180 x 80 - 130 left	200 x 80 - 130 left	220.7 x 80/80 left	240.7 x 80/80 left	220 x 80/130 Ø left	240 x 80/130 Ø left
Weight H 72/75 cm	44.5 kg/45 kg	47.5 kg/48 kg	39.5/40 kg	43.5/44 kg	51.5/52 kg	55.5/56 kg	59.5/60 kg	62.5/63 kg
Variant on the right	2032.188	2032.208	2034.188	2034.208	2030.228	2030.248	2036.228	2036.248

OPTIONS
Chrome-plated frame
Table height optional 72 or 75 cm
Height adjustment 10 cm
Round cable outlet
Grille cable channel
CPU holder
Felt floor protectors
Front and side panel, 33 cm high



	PENTAGON EXTENSION				HEXAGON EXTENSION			
MODEL	2009.127	2009.128	2011.127	2011.128	2010.127	2010.148	2012.127	2012.148
Dimensions in cm	120 x 120, table depth and seat width 70	120 x 120, table depth 80 each, seat width 56	120 x 120, table depth and segment width 70	120 x 120, table depth 80 each, segment width 56	120 x 120, table depth and seat width 70	137 x 137, table depth and seat width 80	120 x 120, table depth and segment width 70	137 x 137, table depth and segment width 80
Weight H 72/75 cm	37.5/38 kg	37.5/38 kg	37.5/38 kg	37.5/38 kg	37.5/38 kg	45.5/46 kg	37.5/38 kg	45.5/46 kg

	90° CORNER EXTENSION					
MODEL	2014.070	2014.080	2014.090	2015.070	2015.080	2015.090
Dimensions in cm	Board dimensions 70, R = 60	Board dimensions 80, R = 70	Board dimensions 90, R = 80	Board dimensions 70	Board dimensions 80	Board dimensions 90
Weight H 72/75 cm	12/12.5 kg	15/15.5 kg	19/19.5 kg	9.5/10 kg	11.5/12 kg	14.5/15 kg

	SEMI-OVAL 80 CM EXTENSION				
MODEL	2013.128	2013.148	2013.168	2013.188	2013.208
Dimensions in cm	120 x 80	140 x 80	160 x 80	180 x 80	200 x 80
Weight H 72/75 cm	32.5/33 kg	35.5/36 kg	38.5/39 kg	41.5/42 kg	44.5/45 kg

OPTIONS SERIES	PENTAGON	HEXAGON	90° CORNER EXTENSION	SEMI-OVAL 80 CM
Chrome-plated frame	■	■		■
Table height optional 72 or 75 cm	■	■		■
Table top with 40 mm corner radius	■	■	■	
Height adjustment 10 cm	■	■		■
Round cable outlet	■	■	■	
Grille cable channel	■	■	■	
Felt floor protectors	■	■		■
Front and side panel, 33 cm high	■	■	■	■

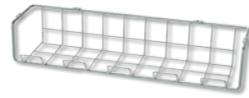

Grille cable channel as accessory for the organisation of cables



Table top optional with cable outlet



Fixed castor for retrofitting on the transverse or longitudinal side of the tables

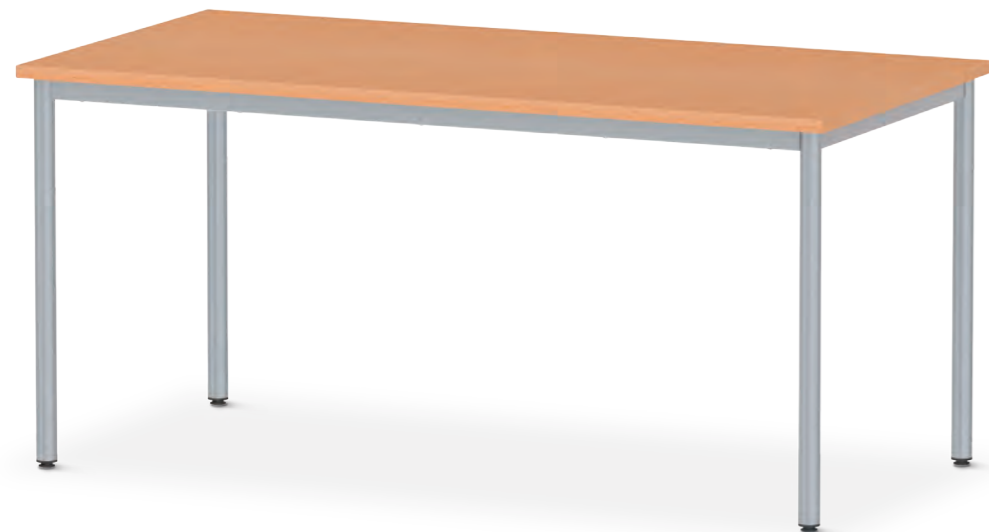

1001.168 4-legged table with welded frame

Further information on accessories on page 83

1000 SERIES | WELDED METAL TABLE SYSTEM



- welded, absolutely robust metal frame, scratch-resistant powder-coated or chrome-plated
- side parts made of round tube (40 x 2 mm), frames made of square tube (40 x 20 x 2 mm)
- plastic floor protectors with level compensation
- optional with castors
- many different table top sizes and shapes
- 25 mm thick finish board in a particularly scratch-resistant and shock-proof design
- as standard we deliver the table with a 3 mm plastic edge in the color of the top, for finish selection see A2S material overview
- see further possible table top designs in ASSODUR® or 12 mm compact board under OPTIONS, color selection see A2S material overview
- many accessories, e.g. various table attachments and panels, please contact your A2S area manager
- available with frame sizes 3-7 according to DIN ISO 5970 and table heights 72 and 75 cm



TABLE COMBINATIONS WITH 90° TRIANGULAR TABLES

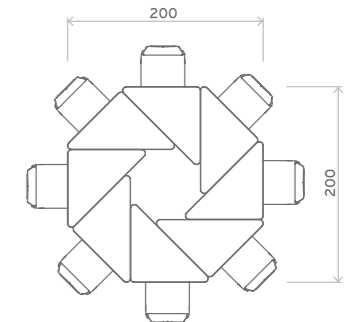
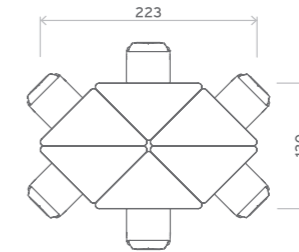
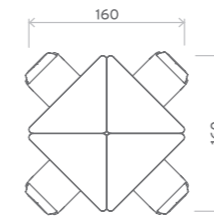

Group work	4	6	8
------------	---	---	---

	60 CM DEEP		65 CM DEEP			70 CM DEEP			
MODEL	1001.066*	1001.126	1001.302	1001.303	1001.304	1001.077	1001.127	1001.147	1001.167
Dimensions in cm	60 x 60	120 x 60	75 x 65	130 x 65	150 x 65	70 x 70	120 x 70	140 x 70	160 x 70
Weight · Size 6	13 kg	22 kg	16 kg	26 kg	28 kg	16 kg	23 kg	28 kg	31 kg

*ATTENTION: Consider the width of the chair frame!

	80 CM DEEP						SEMICIRCLE			
MODEL	1001.088	1001.128	1001.148	1001.168	1001.188	1001.208	1005.126*	1005.302	1005.147	1005.168
Dimensions in cm	80 x 80	120 x 80	140 x 80	160 x 80	180 x 80	200 x 80	120 x 60	130 x 65	140 x 70	160 x 80
Weight · Size 6	21 kg	28.5 kg	29 kg	35 kg	40 kg	45 kg	20 kg	21 kg	23 kg	28 kg

*ATTENTION: Consider the width of the chair frame!

	60° TRAPEZOID				67.5° TRAPEZOID	90° TRIANGLE	
MODEL	1004.126*	1004.302	1004.147	1004.168	1074.116*	1003.118	1003.129
Dimensions in cm	120 x 60 x 60	130 x 65 x 65	140 x 70 x 70	160 x 80 x 80	106 x 60 x 60	110 x 80 x 80	124 x 90 x 90
Weight · Size 6	18 kg	20 kg	22 kg	28 kg	17 kg	26 kg	28 kg

Guide rails with Tidy Box A4

*ATTENTION: Consider the width of the chair frame!

OPTIONS SERIES	RECTANGLE	SEMICIRCLE	60° TRAPEZOID	67.5° TRAPEZOID	90° TRIANGLE
Chrome-plated frame	■	■	■	■	■
Glued	■	■	■	■	■
Compact board 12 mm	■	■	■	■	■
ASSODUR® edge	■	■	■	■	■
Table top with 40 mm corner radius	■	■	■	■	including*
Round cable outlet	■	■	■	■	■
Grille cable channel	■	■	■	■	■
Felt floor protectors	■	■	■	■	■
2 fixed castors for longitudinal or transverse side	■	■	■	■	■
Tidy Box	■	■	■	■	■

*only available with 40 mm corner radius

S-SHAPED TABLES:

Countless variable table combinations for all purposes can be "put together" from the numerous table top shapes and sizes.



"S-SHAPE" TABLES	RECTANGLE				60° TRAPEZOID
MODEL	1016.066*	1016.126	1016.077	1016.147	1018.147
Dimensions W x D in cm	60 x 60	120 x 60	70 x 70	140 x 70	140 x 70 x 70
Weight · Size 6	13 kg	22 kg	15 kg	28 kg	26 kg
Info	Corner radius: 40 mm				Corner radius: 40 mm
ASSODUR® edge	■	■	■	■	■

*ATTENTION: Consider the width of the chair frame!

"S-SHAPE" TABLES	SEMICIRCLE	60° TRIANGLE
MODEL	1019.147	1017.077
Dimensions W x D in cm	140 x 70	70 x 70 x 70
Weight · Size 6	23 kg	13 kg
Info	Corner radius: 40 mm	
ASSODUR® edge	■	■

OPTIONS | SERIES S-SHAPED TABLES

- Chrome-plated frame
- Glued
- Felt floor protectors
- 2 fixed castors for longitudinal or transverse side

TABLE COMBINATIONS WITH S-SHAPED TABLES

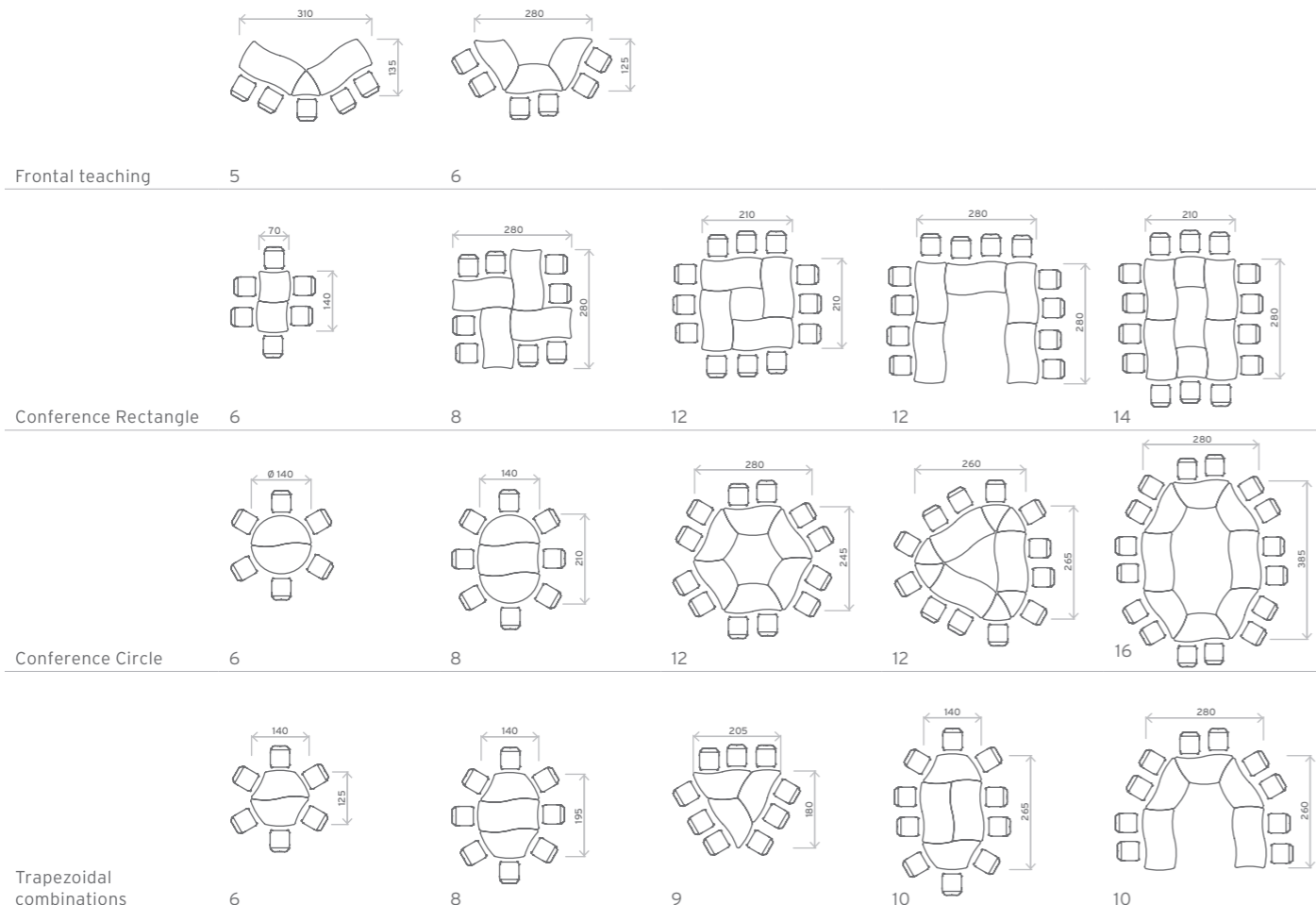

LINKING AND STACKING TABLES:

Easily stackable without dismantling to save space: Simply lift a few centimetres and slide it over the lower table; the welded frame makes them particularly stable.



1023.077 Linking and stacking table with protruding legs on the longitudinal side



Gapless connection despite protruding legs



Stackable up to 6 tables

LINKING AND STACKING TABLES	PROTRUDING LEGS ON LONGITUDINAL SIDE			
MODEL	1023.077	1023.088	1023.147	1023.168
Dimensions W x D in cm	70 x 70	80 x 80	140 x 70	160 x 80
Weight · Size 6	16 kg	18 kg	23 kg	28 kg

OPTIONS | LINKING AND STACKING TABLES SERIES

- Chrome-plated frame
- Glued
- Felt floor protectors
- 2 fixed castors for longitudinal or transverse side





Solid beech wood table frame, with wooden frame on all sides



5822 4-legged rectangular table with wooden frame, Frame of wooden studs half round beech lacquered

WOODEN TABLES



- solid beech wooden table frame from sustainable forestry, environmentally friendly lacquered with water-based lacquer
- 25 mm thick working surface with additional melamine resin coating, thus scratch-resistant, shock-proof and glare-free
- as standard we deliver the table with a 3 mm plastic edge in the color of the top, for finish selection see A2S material overview
- many different table top sizes and shapes
- optional edge beech concealed edge band crowned natural lacquered
- tables available in heights 72 or 75 cm



5822 Table with wooden frame
7414 WAVE cantilever chair with seat and back upholstery

WOODEN TABLES	70 CM					80 CM				
MODEL	5820	5821	5822	5823	5824	5800	5801	5802	5803	5804
Dimensions W x D in cm	70 x 70	120 x 70	140 x 70	160 x 70	190 x 70	80 x 80	120 x 80	140 x 80	160 x 80	190 x 80
Weight H 72/75 cm	16.5/17 kg	24.5/25 kg	26.5/27 kg	31.5/32 kg	35.5/36 kg	19.5/20 kg	27.5/28 kg	30.5/31 kg	34.5/35 kg	39.5/40 kg

WOODEN TABLES	TRAPEZOIDAL		SEMICIRCLE	
MODEL	5807	5817	5818	5808
Dimensions W x D in cm	160 x 80 x 80	140 x 70 x 70	140 x 70	160 x 80
Weight H 72/75 cm	32.5/33 kg	26.5/27 kg	26.5/27 kg	32.5/33 kg

OPTIONS	RECTANGLE	TRAPEZOIDAL	SEMICIRCLE
Stained frame	■	■	■
Glued	■	■	■
Concealed edge band crowned	■	■	■
Round cable outlet	■		
Grille cable channel	■		
Felt floor protectors	■	■	■
Table height optional 72 or 75 cm	■	■	■

TABLE ATTACHMENTS, FRONT AND SIDE PANELS FOR METAL TABLE SYSTEM

- cover board as well as sides and front with melamine coated finishboard in particularly scratch-resistant and shock-proof design, 60 Series in corpus construction or 20 Series with holder made of round tube 40 x 2 mm powder-coated, see A2S material overview
- 3 mm and 1 mm plastic edge in board color, for finish selection see A2S material overview
- 20 Series available with one-sided or double-sided linking
- fixing of front and side panels with steel panel holder, powder-coated, see A2S material overview



20 Series elegant appearance: continuous table leg and with matching front and side panels



20 Series high and deep enough for standard folders

TABLE TOPS | HEIGHT 36 CM FOR RECTANGULAR TABLES



MODEL	2053.080	2053.090	2053.100	2053.120	2053.140	2053.160	2053.180	2053.200
Freestanding								
Linking one-sided left/right	2053.081	2053.091	2053.101	2053.121	2053.141	2053.161	2053.181	2053.201
Linking double-sided	2053.082	2053.092	2053.102	2053.122	2053.142	2053.162	2053.182	2053.202
Dimensions W x D	80 x 36 cm	90 x 36 cm	100 x 36 cm	120 x 36 cm	140 x 36 cm	160 x 36 cm	180 x 36 cm	200 x 36 cm

TABLE ATTACHMENTS | HEIGHT 36 CM FOR PENTAGONAL TABLES FOR HEXAGONAL TABLES



MODEL	2055.070	2054.070	2054.080
Freestanding			
Linking one-sided left/right	2055.071	2054.071	2054.081
Linking double-sided	2055.072	2054.072	2054.083
Dimensions W x D	120 x 120 cm	120 x 120/70 cm	137 x 137/80 cm

OPTIONS | TABLE ATTACHMENTS

Chrome-plated frame (20 Series only)
Glued
Table top with corner radius 40 mm (only table attachments for rectangular tables)

TABLE ATTACHMENTS | DEPTH 26 CM FOR RECTANGULAR TABLES | 23 OR 32.6 CM HEIGHT FOR CORNER SOLUTIONS | 36 CM HEIGHT



MODEL	6010	6011	6012	6013	6014	6015	6016	6020	6021	6022	6023	6024
Table length in cm	80	90	120	140	160	180	190	80 x 80	110 x 110	80 x 80	80 x 80	80 x 80
For corner board								90°	90°	30°	45°	60°

FRONT AND SIDE PANELS | HEIGHT 33 CM



MODEL	2050.060	2050.070	2050.080	2050.090	2050.100	2050.120	2050.140	2050.150	2050.160	2050.180	2050.200
Front and side panel											
Linking one-sided left/right	2050.061	2050.071	2050.081	2050.091	2050.101	2050.121	2050.141	2050.151	2050.161	2050.181	2050.201
Linking double-sided	2050.062	2050.072	2050.082	2050.092	2050.102	2050.122	2050.142	2050.152	2050.162	2050.182	2050.202
For table depth	60 cm	70 cm	80 cm	90 cm	100 cm	120 cm	140 cm	150 cm	160 cm	180 cm	200 cm
Dimensions B	46.8 cm	56.8 cm	66.8 cm	76.8 cm	86.8 cm	106.8 cm	126.8 cm	136.8 cm	146.8 cm	166.8 cm	186.8 cm
	50.8 cm	60.8 cm	70.8 cm	80.8 cm	90.8 cm	110.8 cm	130.8 cm	140.8 cm	150.8 cm	170.8 cm	190.8 cm
	54.8 cm	64.8 cm	74.8 cm	84.8 cm	94.8 cm	114.8 cm	134.8 cm	144.8 cm	155.8 cm	174.8 cm	194.8 cm

ACCESSORIES FOR TABLE SYSTEMS



Individually extendable and linkable

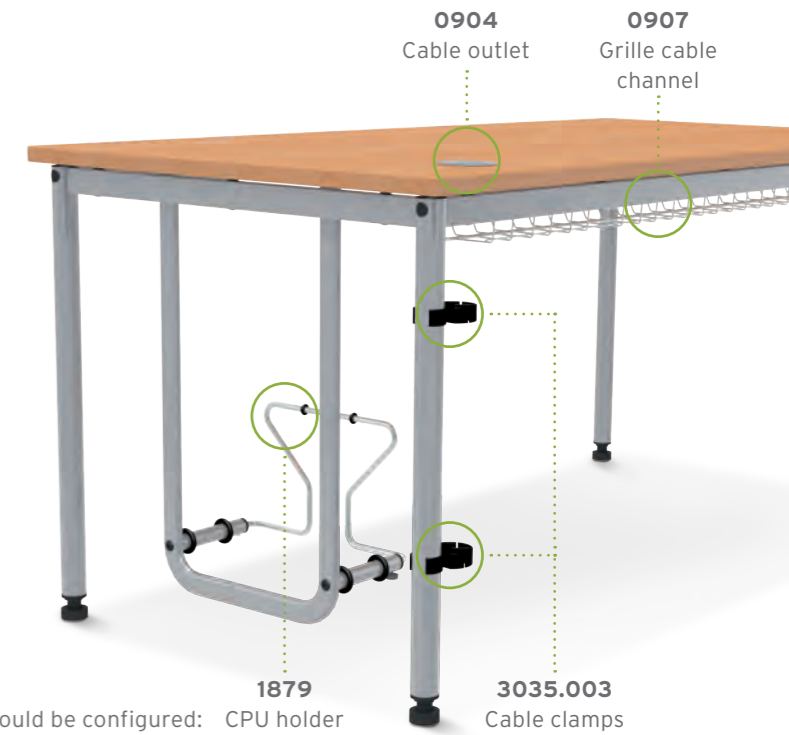

EXAMPLE

This is how your table could be configured: CPU holder Cable clamps

	CONNECTOR	KEYBOARD DRAWER	SCHUKO SOCKET	FIXED CASTOR
MODEL	0224	0227	0909	0179
Description	Connection clamp for beech table system oval wood, galvanised steel	Universal connector for 1000 and 2000 table system, galvanized steel	Keyboard drawer 53 x 5,5 x 21 cm	6-way Schuko socket black-grey, with 3 m supply cable

WIRE GRILLE CABLE CHANNEL CABLE CONDUIT

	0908	0906	0907	0163
MODEL	0908	0906	0907	0163
Description	450 mm length	880 mm Length	1280 mm length	vertical, for conference and writing desks, plastic, grey

CABLE OUTLET CABLE CLAMP CPU HOLDER INLAY SHEET

	0904	3035.002	3035.003	1879	520835
MODEL	0904	3035.002	3035.003	1879	520835
Description	Plastic, matt chrome-plated Ø 80 mm	Die-cast zinc matt nickel-plated Ø 90 mm	Plastic, Ø 38-40 mm	incl. additional fixing under the table top, not for sliding top tables, adjustable from 160-255 mm, max. height of CPU: 500 mm, oval and square tube powder-coated	Inlay sheet in CPU holder for retrofitting Mini PC/Tower



Table partition with fabric cover:
Pinboard, privacy and glare protection in one

FLEXIBLE TABLE PARTITION SYSTEM

- 46 cm high partition wall, quickly mountable to the tabletop using allen key and easily retrofitted
- table partition wall system in 2 different versions:
3-layer finish board, 25 mm (E1) with 3 mm plastic edge in board color or robust softwood sandwich board as pinboard with fabric cover according to A2S color chart, sound-absorbing
- fastening to round steel tube, Ø 40 x 2 mm, powder-coated or chrome-plated
- suitable for 1000 and 2000 table systems from 60 to 200 cm width
- corner solutions possible
- you will find our selection of fabrics, finishes and steel colors in the A2S material overview

OPTIONS

Chrome-plated frame

Material groups 1-3

Magnetic

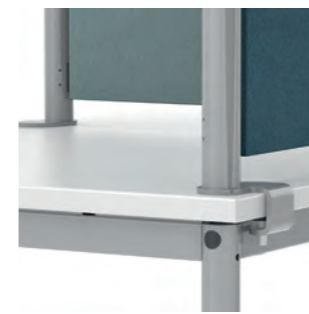

Mounting by means of allen screw on the table top; installation of the partition walls is also possible on triangular and semicircular tables. You will find the A2S table systems from p. 78.



Connection of
T-shaped partition walls



Coherent color concept: The finish and fabric colors of the partition wall system match the table tops and table panels as well as the chairs' upholstery colors.



The 46 cm high partition walls allow more concentrated work due to less distraction, also available with tables with one-sided or double-sided linking.

TABLE PARTITION SYSTEM | HEIGHT 46 CM



for single tables	1099.060	1099.070	1099.080	1099.090	1099.100	1099.120	1099.140	1099.150	1099.160	1099.180	1099.200
Partition wall width in cm	46.8	56.8	66.8	76.8	86.8	106.8	126.8	136.8	146.8	166.8	186.8
for side partition*	1098.060	1098.070	1098.080	1098.090	1098.100						
Partition wall width in cm	46.8	56.8	66.8	76.8	86.8						
for one-sided linking	1099.061	1099.071	1099.081	1099.091	1099.101	1099.121	1099.141	1099.151	1099.161	1099.181	1099.201
Partition wall width in cm	50.8	60.8	70.8	80.8	90.8	110.8	130.8	140.8	150.8	170.8	190.8
for double-sided linking	1099.062	1099.072	1099.082	1099.092	1099.102	1099.122	1099.142	1099.152	1099.162	1099.182	1099.202
partition wall width in cm	54.8	64.8	74.8	84.8	94.8	114.8	134.8	144.8	154.8	174.8	194.8
for table width, depth in cm	60	70	80	90	100	120	140	150	160	180	200

*optional with metal clamp for T-shaped connection without support column



9232.800 Rolling container handleless with central lock on robust castors with stable cover board
1 utensil drawer, 1 drawer 2 HU, 2 drawers of 3 HU

CONTAINERS/ROLLING CONTAINERS AND BASE UNITS

- containers in 2 different versions:
height 56 cm with sturdy castors for stowing under the table
height 49 cm as a permanently mounted base unit
- low-emission finishboard (19 mm) with 2 mm plastic edge in board color, for finish selection see A2S material overview
- robust fittings and drawers
- including central lock
- accessories for interior separation
- handleless rolling containers with integrated damping function
- handles in different shapes selectable - contact your A2S area manager
- info: the height of the drawers is indicated in "HU"; 1 HU = 5.3 cm



9109.601 1 utensil drawer, 1 drawer 2 HU, 2 drawers of 3 HU







9109.603 1 utensil drawer, 2 drawers of 2 HU each, 1 drawer 4 HU



9109.604 1 utensil drawer, 1 drawer 2 HU, 1 drawer 6 HU incl. suspension file insert DIN A4





9109 SERIES | ROLLING CONTAINER | W 44 X H 57 CM (FOR STOWING UNDER THE TABLE)

				
MODEL 60 CM DEEP	9109.601	9109.603	9109.604*	9109.605
MODEL 80 CM DEEP	9109.801	9109.803	9109.804*	9109.805
Equipment	Utensil drawer 1 HU 1 drawer 2 HU 2 drawers à 3 HU	Utensil drawer 1 HU 2 drawers à 2 HU 1 drawer 4 HU	Utensil drawer 1 HU 1 drawer 2 HU 1 drawer 6 HU*	lockable door right/left selectable incl. 1 shelf

9231/9232 SERIES | ROLLING CONTAINER HANDLELESS | W 44 X H 57 CM (FOR STOWING UNDER THE TABLE)





		
MODEL 60 CM DEEP	9231.600	9232.600
MODEL 80 CM DEEP	9231.800	9232.800
Equipment	Utensil drawer 1 HU 1 Drawer 2 HU 1 drawer 6 HU	Utensil drawer 1 HU 1 Drawer 2 HU 2 drawers 3 HU

9119 SERIES | BASE UNITS | W 43 X H 50 CM

					
MODEL 65 CM DEEP	9119.701	9119.703	9119.704*	9119.705	9115.701
MODEL 75 CM DEEP	9119.801	9119.803	9119.804*	9119.805	
Equipment	Utensil drawer 1 HU 1 drawer 2 HU 2 drawers à 3 HU	Utensil drawer 1 HU 2 drawers à 2 HU 1 drawer 4 HU	Utensil drawer 1 HU 1 drawer 2 HU 1 drawer 6 HU*	lockable door right/left selectable incl. 1 shelf	2 drawers each 12,4 cm

*incl. Suspension file insert DIN A4

Accessories for rolling containers and base units

ADJUSTMENT BOARD	STAMP HOLDER	PARTITION WALLS	HANDLES
			
0933 for subdivision	0931 Stamp holder strip	0934 DIN A4	0935 DIN A5
			contact your A2S area manager





Multifunctional benefit with back wall in magnetic design



9131.080 Pull-out pantry body pure white U400, front maple D033



9131.080 Pull-out pantry with 2 shelves and 4 Tidy Boxes



Large handle for comfortable opening



9135.080 Pull-out pantry with suspension file

CONTAINERS/PULL-OUT PANTRIES



- low-emission finish board (19 mm) with gapless plastic edge in board color, for finish selection see A2S material overview
- front color freely selectable
- back wall optional white magnetic or as pin board with cork coating
- complete opening by full extension
- lockable
- 3 different equipment variants: Storage compartments with suspension file or Tidy Boxes and bag compartment
- Tidy Boxes in 2 different sizes selectable: 4 x small or 2 x large or 2 x small and 1 x large



Lots of storage space directly at the workplace
9133.080 Pull-out pantry with 3 shelves, lockable
5580.149 OFFICE desk motorised height adjustable
9335 WAVE gas-lift swivel chair with seat and back upholstered with wave padding



Combination of privacy screen and storage space. The height is chosen exactly so that the shelf can be used as a counter for small meetings.

913ER SERIES | PULL-OUT PANTRIES



MODEL	9131.080	9132.080	9133.080	9134.080	9135.080	9136.080
Equipment	2 storage compartments 1 bag compartment 4 Tidy Boxes	2 storage compartments 1 bag compartment 4 Tidy Boxes	3 storage compartments	3 storage compartments	2 storage compartments 1 pocket compartment hanging file	2 storage compartments 1 pocket compartment hanging file
Dimensions W/H/D	45 x 109 x 82 cm	45 x 109 x 82 cm	45 x 109 x 82 cm	45 x 109 x 82 cm	45 x 109 x 82 cm	45 x 109 x 82 cm
Table on the side of the table	left	right	left	right	left	right
Suitable table depth	80 cm	80 cm	80 cm	80 cm	80 cm	80 cm
Lockable	■	■	■	■	■	■

OPTIONS

Magnetic backplane	■	■	■	■	■	■
Back wall covered with cork	■	■	■	■	■	■



A2S CORPUS FURNITURE

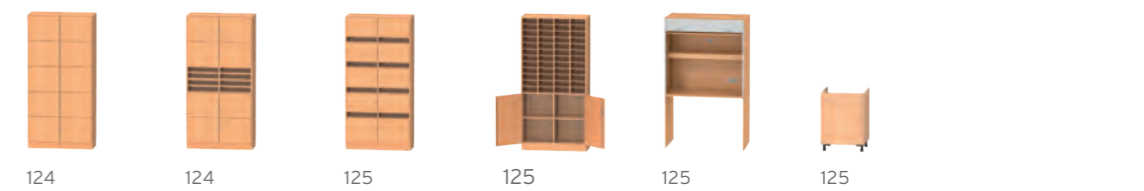
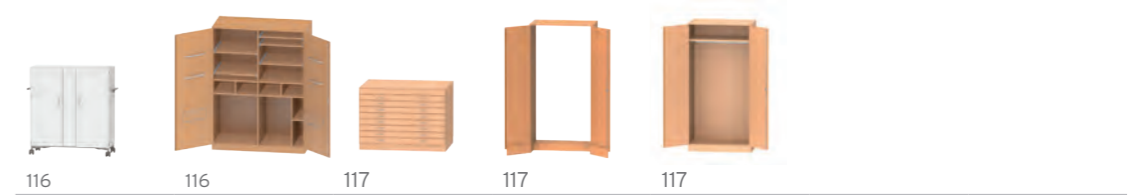
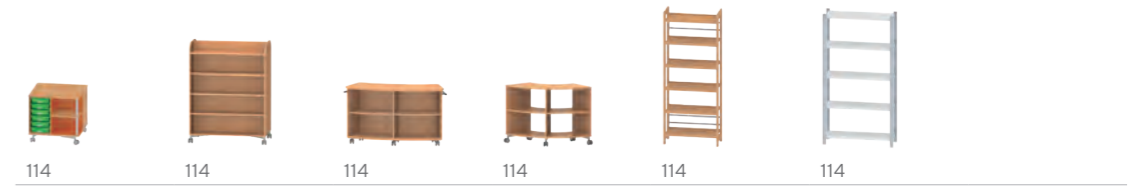

CUSTOM-MADE CABINETS

Things always have to be stored well and safely in educational institutions. Ideally, our A2S cabinet system in the EURO grid DIN 18000 can be adapted to any situation, from a single item to a wall unit to a built-in cabinet. This means that a solution can always be found for the most diverse rooms. And you can be sure that you purchase A2S quality from Germany, persistent and resilient.

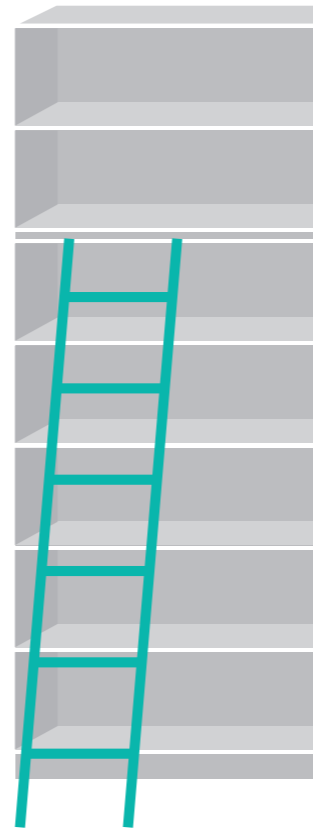

BASIC CONSTRUCTION

- low-emission, 19 mm thick 3-layer fish board according to DIN EN 14 322 (E1), shock-proof, scratch- and abrasion resistant
- the plastic edges in board color are 1-2 mm thick (info p. 158)
- all cabinets are firmly doweled and glued ex works; it guarantees high stability and smooth, quick assembly
- all back walls made of 8 mm thick, low-emission 3-layer finish board are grooved and glued all around
- shelves on metal shelf supports with pull-out protection are adjustable by means of row hole drilling
- the opening hinged doors can be opened by the stable, visible all-metal bands up to 240 degrees
- locks with exchangeable cylinder core are optionally available with plate or pin cylinder available
- different base variants enable an optimal adaptation to the room and use. Standard bases are available with independently selectable finish and also up to 3 FH, also roller frames with rubberised castors are possible - thus makes them mobile cabinets

A2S CABINET SYTEM STANDARD DIMENSIONS

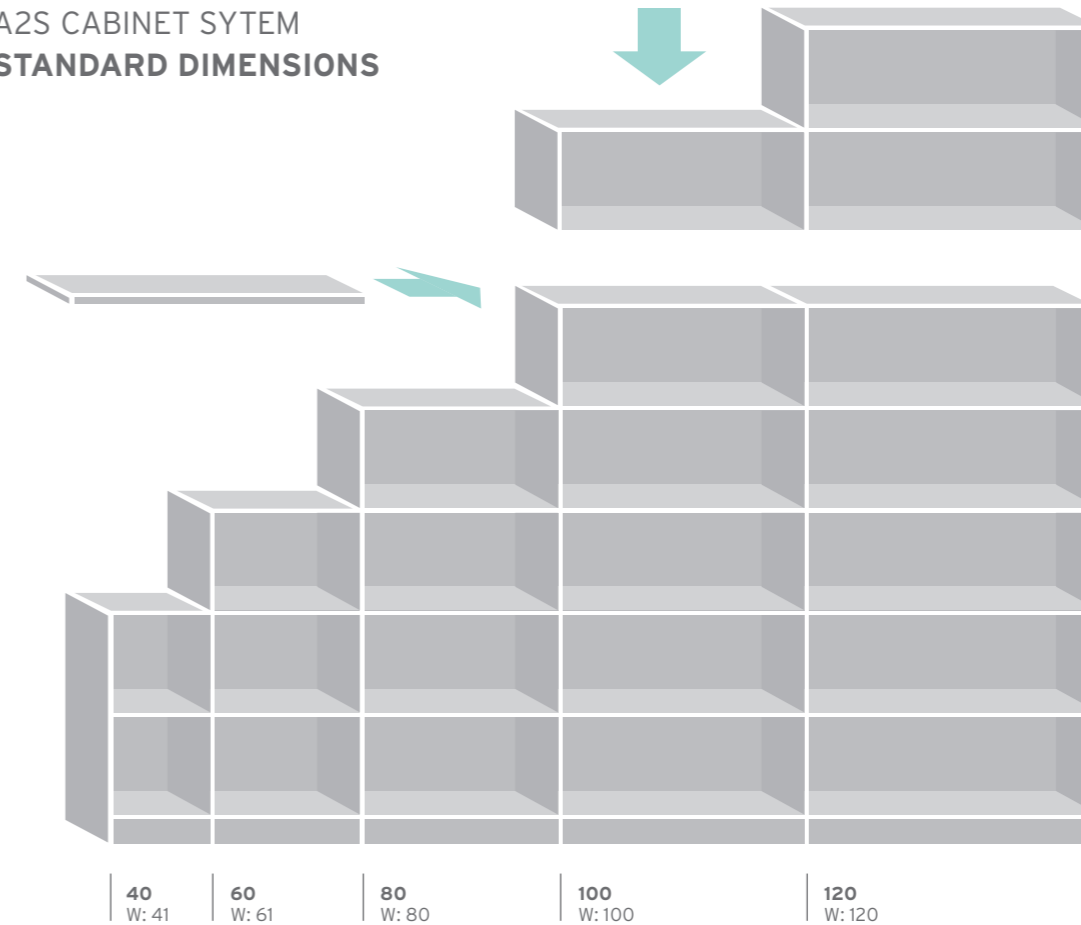

POSSIBILITIES FOR INDIVIDUAL ADAPTATION

- heights and depths of the cabinets can be modified in a grid of 32
- widths can be freely selected individually to make the most of the room
- maximum corpus dimensions of 125 x 250 x 70 cm are possible
- possible base heights for wooden base: 60, 100, 150 cm
- 1-part and 2-part combination cabinets, see pages 100/101



CH = Cabinet height
CorH = Corpus height
CAH = Corpus attachment height
FH = Folder height
1 FH = 38.4 cm

Cabinet depths:
42 cm or 58 cm,
plus front thickness
of 2 cm
e.g. for hinged doors

Cabinet heights: refer
to a 10 cm high base

COMBINATION CABINETS 1-PART

■ 1-part combination cabinets have fixed combinations in 5 FH

COMBINATION CABINETS 1-DOOR	LOCKABLE		COMBINATION CABINETS 2-DOOR SPLIT DOORS	LOCKABLE ON ONE SIDE		LOCKABLE ON BOTH SIDES	
							
FH	5	5	FH	5	5	5	5
Height	204 cm	204 cm	Height with base	204 cm	204 cm	204 cm	204 cm
Number of shelves	2+1	2+1	Number of shelves	6	6	6	6
Center panel			Center panel	■	■	■	■
DEPTH	44 cm	60 cm	DEPTH	44 cm	60 cm	44 cm	60 cm
Width 41 cm	4235.250	4236.250	Width 80 cm	4377.650	4378.650	4353.650	4354.650
Width 61 cm	4235.450	4236.450	Width 100 cm	4377.950	4378.950	4353.950	4354.950
			Width 120 cm	4377.850	4378.850	4353.850	4354.850

COMBINATION CABINETS 2-PART

- combinable from two freely selectable cabinet types
- the combination top cabinet (2 FH/3 FH) and top cabinet (2 FH) configure from basic cabinet 2 FH and 3 FH
- the combination top cabinet must have the same width as the base cabinet, two narrow base cabinets and one wide combination top cabinet are not possible



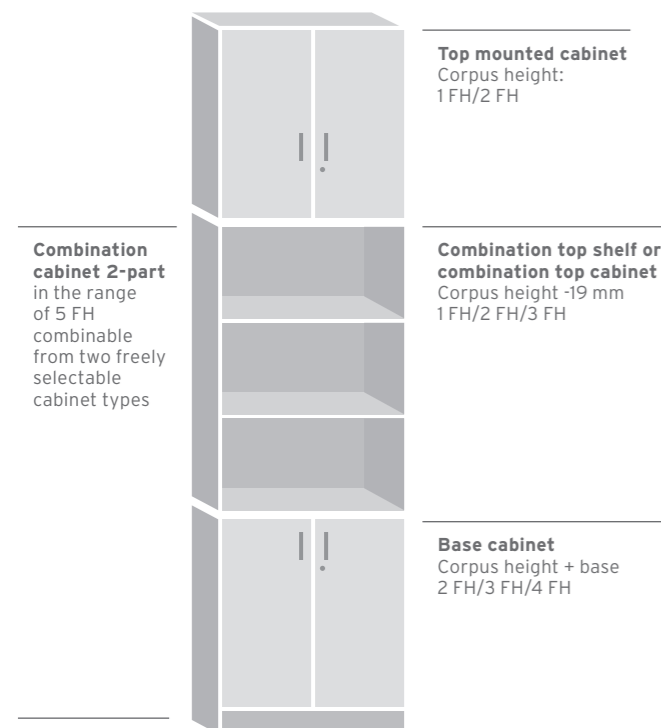

STRUCTURE OF CABINET COMBINATIONS

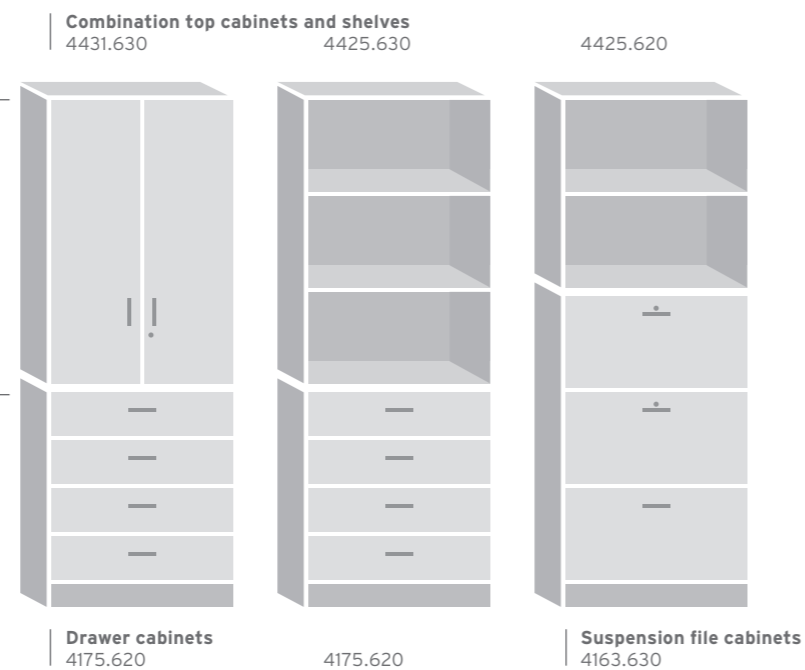

EXAMPLES COMBINATION CABINETS 2-PART

consisting of base cabinet + combination top cabinet or shelf



COMBINATION CABINETS 2-DOOR	LOCKABLE ON ONE SIDE		LOCKABLE ON BOTH SIDES		WITH SUSPENSION FILE CABINET		
							
FH	5	5	5	5	5	5	5
Height	204 cm	204 cm	204 cm	204 cm	204 cm	204 cm	204 cm
Number of shelves	2+2	2+2	4+2	4+2	2	1	1
Number of extracts					2	3	3
Center panel	lower 2 FH	lower 2 FH	continuously	continuously			
DEPTH	44 cm	60 cm	44 cm	60 cm	44 cm	44 cm	60 cm
Width 80 cm	4215.650	4216.650	4485.650	4486.650	4153.650	4155.650	4156.650
Width 100 cm	4215.950	4216.950	4485.950	4486.950			
Width 120 cm	4215.850	4216.850	4485.850	4486.850			

Due to the additional shelf, the combination top cabinet is always 19 mm lower in order to be able to keep to the folder heights and to avoid height offset in cabinet walls.

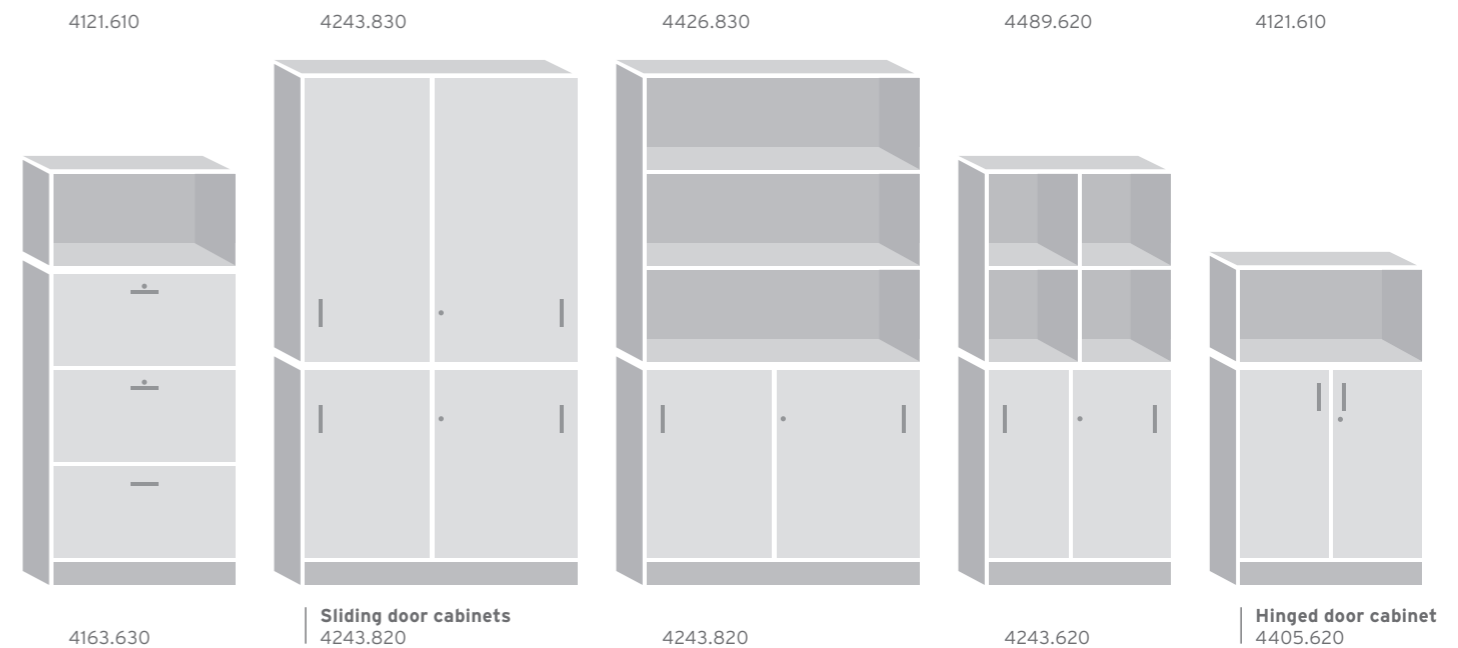

SHELVES

SHELVING UNITS WITHOUT CENTER PANEL										TOP MOUNTED SHELVES*		
FH	5	5	4	4	3	3	2	2	1	1		
Height with base	204 cm	204 cm	165 cm	165 cm	127 cm	127 cm	89 cm	89 cm				
Height top cabinet							79 cm	79 cm	40 cm	40 cm		
Height combi top cabinet					115 cm	115 cm	77 cm	77 cm	38 cm	38 cm		
Number of shelves	4	4	3	3	2	2	1	1				
DEPTH	42 cm	58 cm	42 cm	58 cm	42 cm	58 cm	42 cm	58 cm	42 cm	58 cm		
Width 41 cm	4425.250	4426.250	4425.240	4426.240	4425.230	4426.230	4425.220	4426.220	4121.210	4122.210		
Width 61 cm	4425.450	4426.450	4425.440	4426.440	4425.430	4426.430	4425.420	4426.420	4121.410	4122.410		
Width 80 cm	4425.650	4426.650	4425.640	4426.640	4425.630	4426.630	4425.620	4426.620	4121.610	4122.610		
Width 100 cm	4425.951	4426.951	4425.941	4426.941	4425.931	4426.931	4425.921	4426.921	4121.911	4122.911		
Width 120 cm	4425.850	4426.850	4425.840	4426.840	4425.830	4426.830	4425.820	4426.820	4121.810	4122.810		

*Add-on shelves in 2 FH result from the 2 FH shelf, configured without base.

SHELVING UNITS WITH CENTER PANEL										TOP MOUNTED SHELVES*		
FH	5	5	4	4	3	3	2	2	1	1		
Height with base	204 cm	204 cm	165 cm	165 cm	127 cm	127 cm	89 cm	89 cm				
Height top cabinet							79 cm	79 cm	40 cm	40 cm		
Height combi top cabinet					115 cm	115 cm	77 cm	77 cm	38 cm	38 cm		
Number of shelves	8	8	6	6	4	4	2	2				
DEPTH	42 cm	58 cm	42 cm	58 cm	42 cm	58 cm	42 cm	58 cm	42 cm	58 cm		
Width 80 cm	4489.650	4490.650	4489.640	4490.640	4489.630	4490.630	4489.620	4490.620	4123.610	4124.610		
Width 100 cm	4489.950	4490.950	4489.940	4490.940	4489.930	4490.930	4489.920	4490.920	4123.910	4124.910		
Width 120 cm	4489.850	4490.850	4489.840	4490.840	4489.830	4490.830	4489.820	4490.820	4123.810	4124.810		

*Add-on shelves in 2 FH result from the 2 FH shelf, configured without base.

SUSPENDED SHELVES WITHOUT CENTER PANEL				WITH CENTER PANEL		
FH	2	1	2	1		
Height	79 cm	40 cm	79 cm	40 cm		
Number of shelves	1		2			
Center panel			■	■		
DEPTH	42 cm	42 cm	42 cm	42 cm		
Width 41 cm	4939.220	4939.210				
Width 61 cm	4939.420	4939.410				
Width 80 cm	4939.620	4939.610	4941.620	4941.610		
Width 100 cm	4939.921	4939.911	4941.920	4941.910		
Width 120 cm	4939.820	4939.810	4941.820	4941.810		

CORNER SHELVES					TOP MOUNTED SHELVES*	
OH	5	4	3	2	2	1
Height	204 cm	165 cm	127 cm	89 cm	79 cm	40 cm
Number of shelves	4	3	2	1	1	
DEPTH	70 cm	70 cm	70 cm	70 cm	70 cm	70 cm
Width 70 cm	4062.050	4062.040	4062.030	4062.020	4063.020	4063.010

The bases of corner shelves must always be covered.
For heights 2-4 FH, additional cover boards must be assembled.



FH = folder height
Height specifications refer to a 10 cm high base.

HINGED DOOR CABINETS

1-DOOR | LOCKABLE TOP MOUNTED CABINETS*



FH	5	5	4	4	3	3	2	2	1	1
Height with base	204 cm	204 cm	165 cm	165 cm	127 cm	127 cm	89 cm	89 cm		
Height top cabinet							79 cm	79 cm	40 cm	40 cm
Height combi top cabinet					115 cm	115 cm	77 cm	77 cm	38 cm	38 cm
Number of shelves	4	4	3	3	2	2	1	1	0	0
DEPTH	44 cm	60 cm	44 cm	60 cm	44 cm	60 cm	44 cm	60 cm	44 cm	60 cm
Width 41 cm	4401.250	4402.250	4401.240	4402.240	4401.230	4402.230	4401.220	4402.220	4203.210	4204.210
Width 61 cm	4401.450	4402.450	4401.440	4402.440	4401.430	4402.430	4401.420	4402.420	4203.410	4204.410

*Top-mounted cabinets in 2 FH result from the 2 FH cabinet, configured without base.

2-DOOR | LOCKABLE ON ONE SIDE WITHOUT CENTER PANEL TOP MOUNTED CABINETS*



FH	5	5	4	4	3	3	2	2	1	1
Height with base	204 cm	204 cm	165 cm	165 cm	127 cm	127 cm	89 cm	89 cm		
Height top cabinet							79 cm	79 cm	40 cm	40 cm
Height combi top cabinet					115 cm	115 cm	77 cm	77 cm	38 cm	38 cm
Number of shelves	4	4	3	3	2	2	1	1	0	0
DEPTH	44 cm	60 cm	44 cm	60 cm	44 cm	60 cm	44 cm	60 cm	44 cm	60 cm
Width 80 cm	4431.650	4432.650	4431.640	4432.640	4431.630	4432.630	4431.620	4432.620	4213.610	4214.610
Width 100 cm	4431.950	4432.950	4431.940	4432.940	4431.930	4432.930	4431.920	4432.920	4213.910	4214.910
Width 120 cm	4431.850	4432.850	4431.840	4432.840	4431.830	4432.830	4431.820	4432.820	4213.810	4214.810

*Top-mounted cabinets in 2 FH result from the 2 FH cabinet, configured without base.

2-DOOR | LOCKABLE ON ONE SIDE WITH CENTER PANEL TOP MOUNTED CABINETS*



FH	5	5	4	4	3	3	2	2	1	1
Height with base	204 cm	204 cm	165 cm	165 cm	127 cm	127 cm	89 cm	89 cm		
Height top cabinet							79 cm	79 cm	40 cm	40 cm
Height combi top cabinet					115 cm	115 cm	77 cm	77 cm	38 cm	38 cm
Number of shelves	8	8	6	6	4	4	2	2	0	0
Center panel	■	■	■	■	■	■	■	■	■	■
DEPTH	44 cm	60 cm	44 cm	60 cm	44 cm	60 cm	44 cm	60 cm	44 cm	60 cm
Width 80 cm	4405.650	4406.650	4405.640	4406.640	4405.630	4406.630	4405.620	4406.620	4223.610	4224.610
Width 100 cm	4405.950	4406.950	4405.940	4406.940	4405.930	4406.930	4405.920	4406.920	4223.910	4224.910
Width 120 cm	4405.850	4406.850	4405.840	4406.840	4405.830	4406.830	4405.820	4406.820	4223.810	4224.810

*Top-mounted cabinets in 2 FH result from the 2 FH cabinet, configured without base.

2-DOOR | LOCKABLE ON BOTH SIDES WITH CENTER PANEL TOP MOUNTED CABINETS*



FH	5	5	4	4	3	3	2	2	1	1
Height with base	204 cm	204 cm	165 cm	165 cm	127 cm	127 cm	89 cm	89 cm		
Height top cabinet							79 cm	79 cm	40 cm	40 cm
Height combi top cabinet					115 cm	115 cm	77 cm	77 cm	38 cm	38 cm
Number of shelves	8	8	6	6	4	4	2	2	0	0
Center panel	■	■	■	■	■	■	■	■	■	■
DEPTH	44 cm	60 cm	44 cm	60 cm	44 cm	60 cm	44 cm	60 cm	44 cm	60 cm
Width 80 cm	4441.650	4446.650	4441.640	4446.640	4441.630	4446.630	4441.620	4446.620	4225.610	4226.610
Width 100 cm	4441.950	4446.950	4441.940	4446.940	4441.930	4446.930	4441.920	4446.920	4225.910	4226.910
Width 120 cm	4441.850	4446.850	4441.840	4446.840	4441.830	4446.830	4441.820	4446.820	4225.810	4226.810

*Top-mounted cabinets in 2 FH result from the 2 FH cabinet, configured without base.

WALL UNITS

WALL UNITS	1-DOOR ONE-SIDED LOCKABLE	2-DOOR ONE-SIDED LOCKABLE	2-DOOR ONE-SIDED LOCKABLE WITH CENTER PANEL	2-DOOR LOCKABLE ON BOTH SIDES WITH CENTER PANEL
FH	2	2	1	2
Height	79 cm	79 cm	40 cm	79 cm
Number of shelves	1	1	0	2
DEPTH	44 cm	44 cm	44 cm	44 cm
Width 41 cm	4931.220			
Width 61 cm	4931.420			
Width 80 cm		4933.620	4933.610	4935.620
Width 100 cm		4933.920	4933.910	4935.920
Width 120 cm		4933.820	4933.810	4935.820

FH = folder height
Height specifications refer to a 10 cm high base.



SLIDING DOOR CABINETS

SLIDING DOOR CABINETS WITH CENTER PANEL					TOP MOUNTED CABINETS WITH CENTER PANEL		
FH	3	3	2	2	2	1	1
Height with base	127 cm	127 cm	89 cm	89 cm	89 cm		
Height top cabinet			79 cm	79 cm	79 cm	40 cm	40 cm
Height combi top cabinet	115 cm	115 cm	77 cm	77 cm	77 cm	38 cm	38 cm
Number of shelves	4	4	2	2	2	0	0
DEPTH	42 cm	58 cm	42 cm	58 cm	48 cm	42 cm	58 cm
Width 80 cm	4243.630	4244.630	4243.620	4244.620		4205.610	4206.610
Width 100 cm	4243.930	4244.930	4243.920	4244.920		4205.910	4206.910
Width 120 cm	4243.830	4244.830	4243.820	4244.820		4205.810	4206.810
Width 138 cm						4040.820	

SLIDING DOOR CABINETS WITH CENTER PANEL, LOCKABLE

FH	5	5
Height	204 cm	204 cm
Number of shelves	8	8
Center panel	■	■
DEPTH	62 cm	62 cm
Width 240 cm	4708.850	4706.850

SUSPENSION FILE CABINETS

SUSPENSION FILE CABINETS*				COMBINATION CABINETS WITH TWO DOORS			DRAWER CABINETS
FH	3	3	2	2	5	5	5
Height	127 cm	127 cm	89 cm	89 cm	204 cm	204 cm	204 cm
Number of extracts	3	3	2	2	2	3	3
DEPTH	44 cm	60 cm	44 cm	60 cm	44 cm	44 cm	60 cm
Width 80 cm	4163.630	4164.630	4161.620	4162.620	4153.650	4155.650	4156.650

*can be combined with combination top cabinets

FH	2
Height	89 cm
Number of extracts	4
DEPTH	44 cm
Width 41 cm	4175.220
Width 61 cm	4175.420
Width 80 cm	4175.620

DRAWER CABINETS

ROLLER SHUTTER CABINETS

ROLLER SHUTTER CABINETS								TOP MOUNTED CABINETS			
FH	5	5	4	4	3	3	2	2	1	1	
Height with base	204 cm	204 cm	165 cm	165 cm	127 cm	127 cm	89 cm	89 cm			
Height top cabinet							79 cm	79 cm	40 cm	40 cm	
Height combi top cabinet					115 cm	115 cm	77 cm	77 cm	38 cm	38 cm	
Number of shelves	4	4	3	3	2	2	1	1	0	0	
Center panel											
DEPTH	42 cm	58 cm	42 cm	58 cm	42 cm	58 cm	42 cm	58 cm	42 cm	58 cm	
Width 80 cm	4531.650	4532.650	4531.640	4532.640	4531.630	4532.630	4531.620	4532.620	4533.610	4534.610	
Width 100 cm	4531.950	4532.950	4531.940	4532.940	4531.930	4532.930	4531.920	4532.920	4533.910	4534.910	
Width 120 cm	4531.850	4532.850	4531.840	4532.840	4531.830	4532.830	4531.820	4532.820	4533.810	4534.810	



Color-matched handle bar with grip and without disturbing handle



Extra wide profile strips for more stability

SHUTTERS



White 9010 Aluminium look

MEDIA CADDY



MODEL	9126.001
Dimensions W/H/D in cm	70 x 94 x 70 cm
Number of shelves	1
Info	incl. viewing rear panel, laptop shelf with full extension, ventilation grille, 6-way socket with 3 m cable, 4 castors, 2 of these lockable, cover plate with rounded corners (r=40 mm)



9126.001 Media Caddy

FH = folder height
Height specifications refer to a 10 cm high base.



Cabinet wall with media workstations ideal for working with laptops

Chairs info p. 12

MEDIA WORKSTATIONS

- space-saving integration of media workstations in one cabinet wall
- table top available in sizes ISO 4-7
- optional with cable outlet
- back wall covered with fabric and useable as pin board, see A2S material overview

MEDIA WORKSTATIONS	
DEPTH	48/58 cm
Height	ISO size Table height 4-7
W 80 cm	4750.601
W 100 cm	4750.901
Number of shelves	1



Base units with Tidy Boxes

Tidy Boxes info p. 120

Media workstation can also be integrated individually into cabinet walls

CABINETS FOR SLIDING BOARDS

- ideally combined with the multifunctional board system 120 x 80 cm portrait or landscape format
- additional storage space behind the boards
- can be combined with hinged door and sliding door base units in special heights, for individual planning please contact your A2S area manager

SHELF EXTENSIONS	WITHOUT CENTER PANEL		WITH CENTER PANEL		SHELF EXTENSIONS WITH TIDY BOXES		BASE UNITS WITH TIDY BOXES	
	WITHOUT CENTER PANEL	WITH CENTER PANEL	SHELF EXTENSIONS WITH TIDY BOXES	WITH CENTER PANEL	BASE UNITS WITH TIDY BOXES	WITH CENTER PANEL	WITHOUT CENTER PANEL	
DEPTH	36/42/48/52/58 cm	36/42/48/52/58 cm	48/52 cm	48/52 cm	48 cm	48 cm	48 cm	48 cm
Height	87/128 cm	87/128 cm	87/128 cm	87/128 cm	76 cm	76 cm	76 cm	76 cm
B 80 cm	4730.600	4731.600	4740.070	4741.104	70 cm	105 cm	70 cm	105 cm
W 100 cm	4730.900	4731.900	4740.070	4741.104	Tidy Boxes small, number of Tidy Boxes	4128.421	4128.621	4128.621
W 120 cm	4730.800	4731.800	4740.070	4741.104	Tidy Boxes large, number of Tidy Boxes	4129.423	4129.623	4129.623
Number of shelves	2	4	2	3	6 pieces	9 pieces	6 pieces	9 pieces
Number of Tidy Boxes	2	4	8	12				



CHANGE
multifunctional cabinet with doors at the front and back:
storage, pinboard, whiteboard and room divider in one;
optionally as shelf cabinet or drawer cabinet with tidy boxes

CHANGE CABINET SERIES CABINETS AND SIDEBOARDS



- CHANGE cabinets made of low-emission 3-layer finish board (E1), scratch-resistant coating, for finish selection see A2S material overview
- with a particularly durable plastic edge even in humid climate
- modern rounded aluminium profile corners reduce the risk of injury and make the furniture more resistant
- doors lockable at front and back
- sturdy metal frame with 4 robust, rubberized plastic castors
- CHANGE sideboard without doors with lots of storage space, thanks to Tidy Boxes and large storage compartment



Rounded aluminium profiles

4130.502 CHANGE sideboard
offers space for 16 small or 8 large Tidy Boxes



CHANGE cabinet
with closed doors



4130.503 CHANGE drawer cabinet
with up to 12 small Tidy Boxes



4130.501 CHANGE Shelf cabinet
with 3 shelves

CHANGE	SHELF CABINET	DRAWER CABINET	SIDEBOARD	TIDY BOX SMALL	TIDY BOX LARGE
MODEL	4130.501 with 3 shelves	4130.503 with 2 shelves and 12 small Tidy Boxes	4130.502 without doors, 4 compartments horizontally and 4 compartments vertically	<input type="checkbox"/> 515267 <input type="checkbox"/> 515264 <input type="checkbox"/> 515266 <input type="checkbox"/> 515265 <input type="checkbox"/> 515263	<input type="checkbox"/> 515520 <input type="checkbox"/> 515517 <input type="checkbox"/> 515519 <input type="checkbox"/> 515518 <input type="checkbox"/> 515516
Dimensions W/H/D in cm	104 x 164 x 60	104 x 164 x 60	138 x 100 x 49	31 x 7,5 x 43	31 x 15 x 43

OPTIONS	
Back panel cork linoleum	■





4130.506 CHANGE Caddy with door, lockable



Rounded aluminium profiles

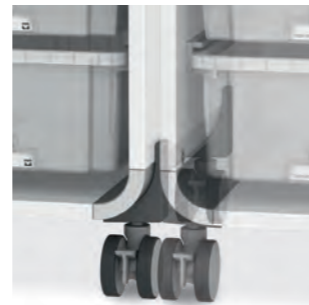

Magnetic linking system for connecting several caddies, e.g. to form a material cabinet



Optionally with magnetic sides

CHANGE CABINET SERIES | CADDIES



- modern rounded aluminium profile corners reduce the risk of injury and make the furniture more resistant
- CHANGE Caddies made of low-emission 3-layer finish board (E1), for finish selection see A2S material overview
- sturdy metal frame with 4 robust, rubberized plastic castors
- multifunctional as storage space at the table, room divider or small counter



4130.505 CHANGE Caddy open on one side



4130.506 CHANGE Caddy with door



4130.507 CHANGE Caddy open on both sides



CHANGE CADDIES



MODEL	4130.505	4130.506	4130.507	9124
Design	Caddy open on one side	Caddy with door, lockable	Caddy open on both sides	Media Caddy with roller shutters and drawers
Dimensions W/H/D in cm	36 x 111 x 55	36 x 111 x 55	36 x 111 x 55	43 x 111 x 65
Weight	31 kg	36 kg	33 kg	56 kg
Number of compartments	2 x storage space 3 small Tidy Boxes or 1 small and 1 large Tidy Box	2 x storage space 3 small Tidy Boxes or 1 small and 1 large Tidy Box	1 x storage space 2 x 3 small Tidy Boxes or 2 x 1 small and 1 large Tidy Box	2 x drawers 1 x pull-out shelf 1 x storage compartment
Magnetic connector	■	■	■	■

OPTIONS

Magnetic side walls	■	■	■	■
---------------------	---	---	---	---



SPECIALIST CLASSROOM CABINETS

LAPTOP CABINET



MODEL	4440.200
Doors	2-door
Dimensions W/H/D	120 x 130 x 52 cm
Number of shelves	16
Design	space for 16 laptops, incl. 2 Tidy Boxes, 2 x 8-way power socket with inrush current limiter, 1 x cable outlet in the back wall on the left for power supply, cable holder on the back wall on the left for winding up the power cable, castor frame with 4 double swivel castors, 2 of which are lockable, 2 furniture handles on the sides, lockable with safety lock



4440.200
Laptop cabinet



From the front, opened



From behind, closed



From behind, opened

INSTRUMENT CABINETS



MODEL	4444.011	4444.012	4444.850
Doors	2-door	2-door	2-door
Dimensions W/H/D	120 x 204 x 60 cm	120 x 204 x 60 cm	150 x 204 x 73 cm
Design	lockable on one side, without center panel, 2 removable shelves, 8 small compartments at bottom right	individually lockable on both sides, with center panel, 8 removable shelves, 10 small compartments on the right, container for small parts on the inside of the doors	individually lockable on both sides, with center panel, 5 removable shelves, 4 small compartments, 3 compartments on the bottom right, holders and containers on the inside of the doors

DRAWING CABINETS DIN A0

DIN A1



MODEL	1181.006	1181.106	1181.008	1181.108
Dimensions W/H/D	135 x 79 x 93 cm	100 x 79 x 68 cm	135 x 98 x 93 cm	100 x 98 x 68 cm
Number of extracts	6	6	8	8

The wooden drawing cabinets are delivered disassembled.

DRAWING CABINETS MADE OF SHEET STEEL DIN A0

DIN A1



MODEL	4182	4183	4185	4186
Powder-coated	RAL 1013 pearl white	RAL 1013 pearl white	RAL 1013 pearl white	RAL 1013 pearl white
Dimensions W/H/D	135 x 76 x 96 cm	135 x 76 x 96 cm	110 x 76 x 76.5 cm	110 x 76 x 76.5 cm
Number of extracts	8	10	8	10

SINK CABINETS

SINK CABINETS



MODEL	4438.650	4438.950	4438.850
Doors	2-door	2-door	2-door
Dimensions W/H/D	80 x 204 x 60 cm	100 x 204 x 60 cm	120 x 204 x 60 cm
Design	lockable on one side, without back wall, with trailing base and recessed bottom panel	lockable on one side, without back wall, with trailing base and recessed bottom panel	lockable on one side, without back wall, with trailing base and recessed bottom panel

WARDROBE CABINETS

WARDROBE CABINETS

WITH LONGITUDINAL EXTENSION ROD

WITH TRANSVERSE CLOTHES RAIL

WARDROBE SHELVES



FH	5	5	5	5	5	5	5	5	5	5
Height	204 cm	204 cm	204 cm	204 cm	204 cm	204 cm	204 cm	204 cm	204 cm	204 cm
Number of shelves	0	0	4	1	2	4	1	1	1	2
Center panel		■	■		■	■				■
DEPTH	44 cm	44 cm	44 cm	60 cm	60 cm	60 cm	60 cm	60 cm	58 cm	58 cm
Width 61 cm	4403.450			4404.450						4419.450
Width 80 cm			4407.650		4448.650	4408.650	4410.650	4419.650	4429.650	
Width 100 cm		4443.950	4407.950		4448.950	4408.950	4410.950	4419.951	4429.950	
Width 120 cm		4443.850	4407.850		4448.850	4408.850	4410.850	4419.850	4429.850	



Hallway cabinets with top mounted cabinets provide sufficient storage space; the integrated seating niche with benches and table for primary pupils creates a cosy area for short breaks or a quiet workplace for individual or group work

Hallway cabinets in 2 widths and 3 equipment variants establish order; the seating niche offers seating comfort in the hallway without having to adjust the escape routes

HALLWAY FURNITURE SYSTEM WITH SEATING NICHES



- flexible for different rooms and budgets
- in 5 FH and 2 different widths for 1 or 2 students
- top mounted cabinet in 1 FH or 2 FH with plenty of storage space
- carrier board material certified hardly flammable according to DIN 4201 B1
- finish white hardly flammable according to DIN 4201 B1
- cabinet-high handle strips, keep the escape route clear and are easy to grip from any height
- optionally all cabinets lockable
- in 3 different equipment variants
- with coat hook for jackets
- with tidy boxes optionally large and small
- small tidy boxes also fit under the A2S tables
- pull-out stools with non-slip foot
- base distributor for levelling
- bodies with connecting screws securely interconnected
- seating niche for primary school with 2 seating benches in TAFF B1 or ARTIFICIAL LEATHER B1 and 1 table
- seating niche for secondary school with one seating bench in button upholstery ARTIFICIAL LEATHER B1
- finish and material color selection see A2S Material overview
- seating niches can also be combined with other 5 FH A2S cabinets, e.g. in the classroom or administrative area
- for individual planning also as a corner solution or with inclined roof please also contact your A2S area manager

HALLWAY CABINETS IN 3 EQUIPMENT VARIANTS FOR 1 OR 2 PUPILS



1 fixed and 3 adjustable shelves

Coat hooks and Tidy Boxes

Coat hook, Tidy Box and stool

HALLWAY FURNITURE SYSTEM	HALLWAY CABINET					TOP MOUNTED CABINET	SEATING NICHE	PRIMARY SCHOOL	SECONDARY SCHOOL
FH	5	5	5	1	2		FH	5	5
Width 36 cm · for 1 pupil	6670.250	6671.250	6672.250	6675.210	6675.220			6680.001	6680.002
Width 48 cm · for 2 pupils	6670.950	6671.950	6672.950	6675.910	6675.920		Dimensions W/H/D in cm	144 x 203.9 x 70	144 x 203.9 x 70
Dimensions H/D in cm	203.9 x 58	203.9 x 58	203.9 x 58	40.3 x 58	78.7 x 58		Seat height	38 cm	50 cm
1 fixed floor above		■	■				Bench	self-supporting	self-supporting
1 fixed floor below	■	■	■				Full upholstery	B1 hardly flammable, PG 2 and 4	B1 hardly flammable, PG 4
Adjustable shelf	3						Seat upholstery thickness, W/D in cm	13.5 cm, 65 x 40 cm	12.3 cm, 140 x 60 cm
Shelf with bottom panel	■						Back upholstery thickness, W/H in cm	6.9 cm, 65 x 50 cm	6.3 cm, 140 x 92 cm
Coat hooks		1/2	1/2				Weight	129 kg	126 kg
Tidy Box bottom large transparent		1					OPTIONS		
Tidy Boxes selectable large/small		2/0 or 1/2 or 0/4	1/0 or 0/2				Top mounted cabinet width 36 cm	4 x mod. 6675.210/6675.220	4 x mod. 6675.210/6675.220
Stool			6690.200/6690.900				Top mounted cabinet width 48 cm	3 x mod. 6675.910/6675.920	3 x mod. 6675.910/6675.920
Finishing side	6674.050	6674.050	6674.050	6674.010	6674.020		Sloping roof one-sided	■	■
Weight	61 kg/71 kg	57 kg/64 kg	70 kg/82 kg	14 kg/17 kg	25 kg/29 kg				
OPTIONS									
Lockable	■	■	■	■	■				
Sloping roof one-sided	■	■	■	■	■				
Sloping roof on both sides	■	■	■	■	■				
Sloping roof corner solution	■	■	■	■	■				





Tidy Boxes keep order in property lockers.



Mountable on different table models.



Removed from the cabinets, the Tidy Boxes can be conveniently and efficiently stowed away at the workplace.



Tidy boxes in 2 sizes and 5 colors

TIDY BOXES



- in 2 sizes and 5 colors
- drawers made of saliva-proof plastic
- removable title block on the narrow side
- lengthwise and transversely insertable through circumferential handle strip
- fully recyclable
- optional: transparent lid

TIDY BOX	SMALL	LARGE	COVER
Dimensions W/H/D	31 x 7.5 x 43 cm	31 x 15 x 43 cm	30 x 1.5 x 42 cm
MODEL	<ul style="list-style-type: none"> ■ 515267 ■ 515264 ■ 515266 ■ 515265 ■ 515263 	<ul style="list-style-type: none"> ■ 515520 ■ 515517 ■ 515519 ■ 515518 ■ 515516 	<ul style="list-style-type: none"> ■ 516340



PLAY BUILD SIT ROL ARRANGE TIDY UP ODDS AND ENDS.

As a playable box on wheels, as a comfortable stool with upholstered lid or simply as a clearly arranged shelf - the versatile odds and ends box quickly creates space for all kinds of things that quickly accumulate, especially in the all-day school routine, and helps to keep the classroom tidy.



4070 Odds and ends box as a mobile stool with upholstered lid and castors



Odds and ends box, connected to the shelf

ODDS AND ENDS BOX



- 40 x 40 x 37 cm cube made of robust, low-emission 3-layer finished panel (E1), scratch-resistant coating
- with patented connecting elements made of stable plastic, which are simply clamped into the handle holes
- the elements can be quickly and safely joined together to form entire shelf walls - and removed again when they are needed in the room
- furniture edges with plastic strips protect against damage
- available in many friendly colors, see A2S material overview
- removable seat upholstery in many colors

ODDS AND ENDS BOX	UPHOLSTERED LIT	CASTORS
4070 40 x 40 x 37 cm	0125 upholstered, cover according to A2S color chart	0175 4 pieces, robust plastic double castors



GLASS DISPLAY CASES

GLASS DISPLAY CASES	2/3 OF THE HEIGHT SAFETY GLASS LOCKABLE ON ONE SIDE				2/3 OF THE HEIGHT SAFETY GLASS INDIVIDUALLY LOCKABLE ON BOTH SIDES		SLIDING GLASS DOORS AT THE TOP AND HINGED DOORS AT THE BOTTOM
FH	5	5	5	5	5	5	5
Height	204 cm	204 cm	204 cm	204 cm	204 cm	204 cm	204 cm
Number of shelves	4	4	4	4	8	8	4+2
Center panel					■	■	■
DEPTH	44 cm	60 cm	44 cm	60 cm	44 cm	60 cm	44 cm
Width 61 cm	4411.450	4412.450					
Width 80 cm							4355.650
Width 100 cm			4413.950	4414.950	4451.950	4452.950	4355.950
Width 120 cm			4413.850	4414.850	4451.850	4452.850	4355.850

DISPLAY CASES



5472 Display case free standing



4815 Display case for wall mounting

DISPLAY CASES



MODEL	5472	5483	5484	5485	4810	4815	4820
Dimensions W/H/D in cm	150 x 170 x 54.5	150 x 100 x 30	150 x 100 x 7.2	200 x 100 x 7.2	100 x 100 x 15	150 x 100 x 15	200 x 100 x 15
Design	freestanding	wall mounting*	wall mounting*	wall mounting*	wall mounting**	wall mounting**	wall mounting**

*with magnetic back wall, optionally back pwall with colored cork coating **back wall with colored cork coating

MAGAZINE CABINETS

MAGAZINE CABINETS



MODEL	4399.850	4398.950
Doors	2-door	2-door
Dimensions W/H/D	120 x 204 x 44 cm	100 x 204 x 44 cm
Design	with 12 magazine flaps, with center panel at the top, bottom 2 FH 2-door, individually lockable on both sides	with 12 magazine flaps, without center panel at the top, bottom 2 FH 2-door, individually lockable on both sides

COUNTER CABINETS

COUNTER CABINETS LOCKABLE



Height	105 cm	105 cm	115 cm	115 cm
Number of shelves	2	2	2	2
DEPTH	42 cm	58 cm	42 cm	58 cm
Width 100 cm	4605.910	4600.910	4605.950	4600.950
Width 120 cm	4605.810	4600.810	4605.850	4600.850
Info	Room divider with 2 sliding doors for secondary schools. Open at the top with 6 small compartments.			

FH = folder height
Height specifications refer to a 10 cm high base.

TEACHER'S COMPARTMENT CABINETS

TEACHER'S COMPARTMENT CABINETS | LOCKABLE



FH	5	5	5	5	5	5
Height	204 cm	204 cm	204 cm	204 cm	204 cm	204 cm
No. of teacher compartments	5	5	10	10	3	6
Number of shelves					1	2
DEPTH	44 cm	60 cm	44 cm	60 cm	44 cm	44 cm
Width 41 cm	4267.250	4268.250			4271.250	
Width 61 cm	4267.450	4268.450			4271.450	
Width 80 cm			4269.650	4270.650		4273.650
Width 100 cm			4269.950	4270.950		4273.950
Width 120 cm			4269.850	4270.850		4273.850

TEACHER'S COMPARTMENT CABINETS | WITH MAILBOXES IN THE MIDDLE



FH	5	5	5	5
Height	204 cm	204 cm	204 cm	204 cm
No. of teacher compartments	4	4	3	3
Number of mailboxes	4	4	3	3
DEPTH	44 cm	60 cm	44 cm	60 cm
Width 41 cm	4279.250	4280.250	4283.250	4284.250
Width 51 cm	4279.950	4280.950		
Width 61 cm	4279.450	4280.450		
Info			lower 2 FH with 1 revolving door	lower 2 FH with 1 revolving door

TEACHER'S LOCKERS CABINETS | WITH MAILBOXES CENTRED | WITH CENTRE PANEL



FH	5	5	5	5	5	5	5	5
Height	204 cm	204 cm	204 cm	204 cm	204 cm	204 cm	204 cm	204 cm
No. of teacher compartments	8	8	8	8	6	6	6	6
Number of mailboxes	8	8	8	8	6	6	6	6
DEPTH	44 cm	60 cm	44 cm	60 cm	44 cm	60 cm	44 cm	60 cm
Width 61 cm	4239.450	4240.450			4287.450	4288.450		
Width 80 cm			4281.650	4282.650			4285.650	4286.650
Width 100 cm			4281.950	4282.950			4285.950	4286.950
Width 120 cm			4281.850	4282.850				
Info					lower 2 FH with 1 revolving door	lower 2 FH with 1 revolving door	lower 2 FH with 2 revolving doors	lower 2 FH with 2 revolving doors

TEACHER'S COMPARTMENTS WITH MAILBOXES UNDERNEATH

TEACHER'S COMPARTMENTS WITH LETTER SLOTS ABOVE

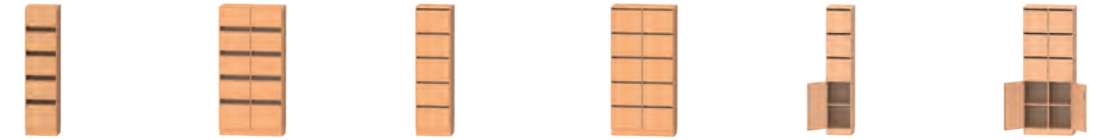

FH	5	5	5	5	5	5
Height	204 cm	204 cm	204 cm	204 cm	204 cm	204 cm
No. of teacher compartments	4	8	5	10	3	6
Number of mailboxes	4	8	5	10	3	6
DEPTH	44 cm	44 cm	44 cm	44 cm	44 cm	44 cm
Width 41 cm	4275.250		4291.250		4295.250	
Width 80 cm		4277.650		4293.650		4297.650
Width 100 cm		4277.950		4293.950		4297.950
Info					lower 2 FH with 1 revolving door	lower 2 FH with 2 revolving doors

MAILBOX CABINETS

MAILBOX CABINETS LOCKABLE



FH	5	5
Height	204 cm	204 cm
Number of mailboxes	24	36/36/48
Number of shelves	1	2
DEPTH	44 cm	44 cm
Width 61 cm	4477.450	
Width 80 cm		4479.650
Width 100 cm		4479.950
Width 120 cm		4479.850

KITCHENETTE CABINETS

KITCHENETTE CABINETS

SINK BASE CABINETS



MODEL	4439.852	4459.100	6354.503	6354.420
Doors	2-door	Roller shutter	1-door	1-door
Dimensions W/H/D	120 x 204 x 67 cm	124 x 204 x 64 cm	52 x 72 x 55 cm	60 x 72 x 55 cm
Design	with carrying base, lockable on one side, supplemented by sink base cabinet 6354.503 and refrigerator or dishwasher	supplemented by sink base cabinet 6354.420 and refrigerator or dishwasher	addition to 4439.852 electrical and water connection on site	addition to 4459.100 electrical and water connection on site

FH = folder height
Height specifications refer to a 10 cm high base.



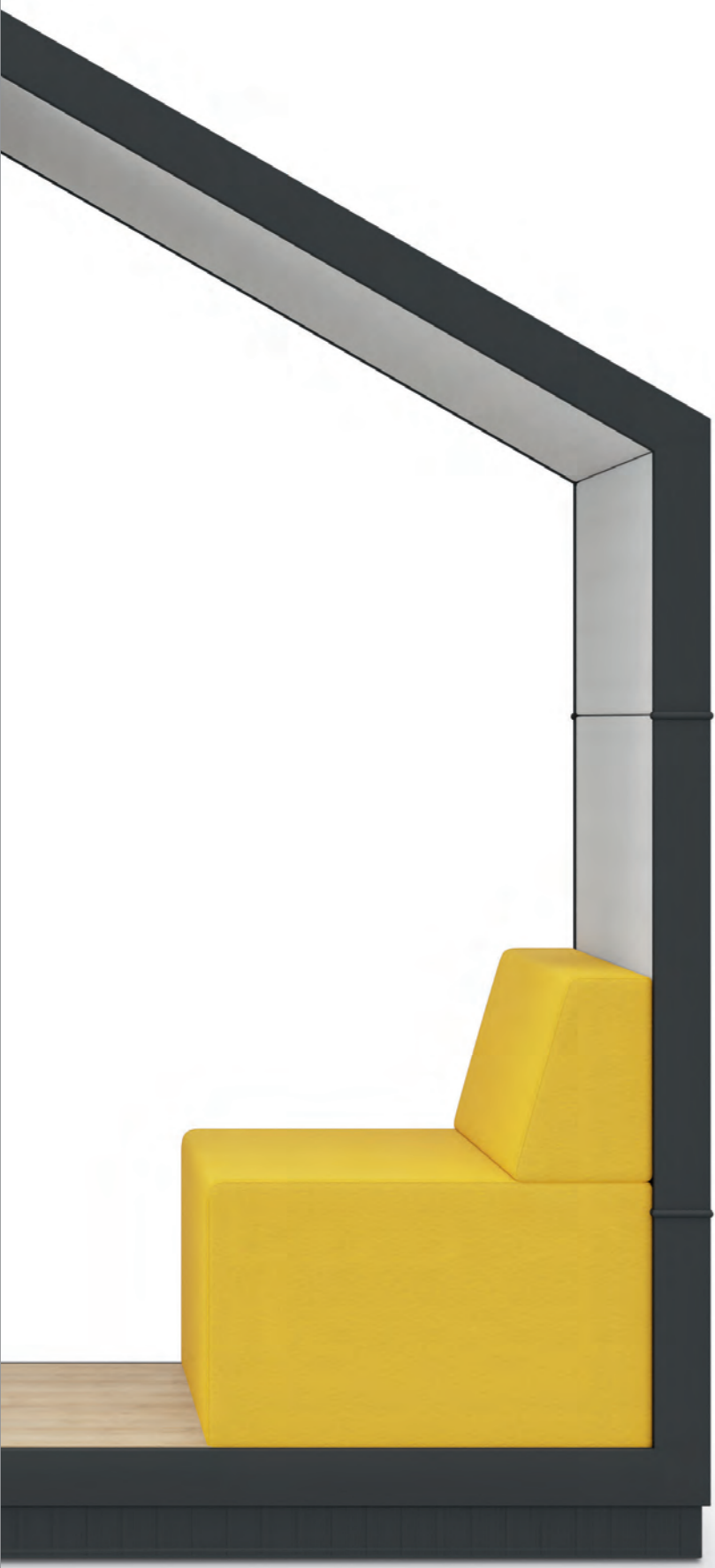

A2S LOUNGE FURNITURE | ACOUSTICS



CHILL HOUSE MEETING HOUSE 128 128 128



DOMINO MAZE 130 130 130 130 130 130



DOMINO HOUSE CYLINDRA BLOC 132 133 133 133 133 133 133



COMFORT HI 134 134 134



Folding couch Folding chair CHILL-Series 135 136 136 136 136 136 136



COMBI partition wall 138 138



ACOUSTIC elements 140 140 140 140



9390.002 CHILL HOUSE WOOD
with exterior walls in natural oak



9390.001 CHILL HOUSE
with exterior walls in fabric

The CHILL House for relaxed breaks or pleasant reading, learning or exchanging. Ideally for hallways, waiting areas and auditoriums.

CHILL HOUSE/MEETING HOUSE

- upholstered elements with backrest: Upholstery made of foam
- height upholstered element with backrest: 68 cm
- upholstery and interior walls optional with fabric TAFF B1 or WOOL, for color selection see A2S material overview
- substructure of robust 3-layer chipboard
- frame construction: Metal frame with closed base powder-coated in RAL 9005 black or RAL 9010 pure white
- flooring in wooden panels natural oak

CHILL HOUSE

- exterior walls available in fabric or wooden panels natural oak, for fabric selection see A2S material overview

MEETING HOUSE

- table frame powder-coated like metal frame
- table top HPL coated, optional in white, anthracite or black
- multimedia connection: 1 x power socket, 1 x USB, 1 x HDMI
- incl. LED light
- optional with glass door and ventilation system

Your A2S area manager will be happy to advise you



9390.003 MEETING HOUSE

space for 4 people, incl. table, multimedia connections and LED light
optional also with glass door and ventilation, for quiet working or undisturbed meetings

	CHILL HOUSE		MEETING HOUSE
MODEL	9390.001	9390.002	9390.003
Dimensions W/H/D in cm	210 x 228 x 78	210 x 228 x 78	210 x 228 x 153
Seat height	33 cm	33 cm	33 cm
Interior walls fabric TAFF B1/WOOL	■	■	■
Exterior walls fabric TAFF B1/WOOL	■	■	■
Exterior walls natural oak		■	
Frame powder-coated black	■	■	
Weight	210 kg	210 kg	500 kg
Packaging note	is delivered disassembled on a pallet: W/H/D: 210 x 190 x 78 cm	is delivered disassembled on a pallet: W/H/D: 210 x 190 x 78 cm	is delivered disassembled on two pallets: 2 x W/H/D: 210 x 190 x 78 cm





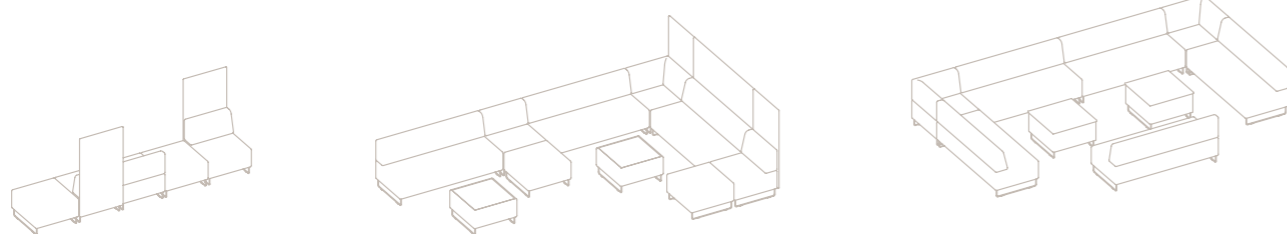

Fits together perfectly and offers numerous design possibilities: DOMINO and MAZE.
For individual planning of your seating arrangements, please contact your A2S area manager.

DOMINO AND MAZE SERIES

- robust construction and durable foams
- easy-care and hard-wearing fabrics and leather covers in a wide selection, in price group 1-4, see A2S material overview
- color combinations freely selectable within a fabric group
- optional with hardly inflammable fabric and leather covers in B1 of price group 2 and 4, see A2S material overview
- freely combinable individual modules, useable individually or in a fixed combination
- optional privacy and noise protection on back and/or sides, only available in fabric group WOOL
- frame powder-coated in RAL 9006 chrome silver as standard or optionally chrome-plated
- table available with finish board or glass board



Combination of
9387.147 MAZE stool with backrest and
9387.002 MAZE stool supplemented by
elements of the CYLINDRA series

MODULE SYSTEM DOMINO	STOOL	STOOL WITH BACKREST	BENCH	EXTERNAL ELEMENT/ CORNER ELEMENT	ARMREST	TABLE WITH GLASS BOARD/ FINISH BOARD
						
MODEL	9384.001	9384.070	9384.165	9384.301R 9384.302L 9384.303E	9384.004	9384.003 9384.006
Dimensions W/H/D in cm	69 x 45 x 69	69 x 74 x 69	165 x 74 x 69	69 x 74 x 69	22 x 52 x 69	69 x 45 x 69
Seat height in cm	45	45	45	45		
Powder-coated frame	skids	skids	skids	skids		skids
Weight	18 kg	24 kg	48 kg	25 kg	9 kg	22 kg

OPTIONS						
Chrome-plated frame	■	■	■	■		■
Felt floor protectors	■	■	■	■		■
Linking	■	■	■	■		■
Privacy screen*		9385.069	9385.165	9385.069		9384.003

*mounted height 135 cm. Only available in fabric group Wool

MAZE	STOOL	STOOL WITH BACKREST	DOMINO PILLOW
			
MODEL	9387.002	9387.147	9384.901
Dimensions W/H/D in cm	80 x 45 x 82	80 x 79 x 82	35 x 35 x 7-9 cm
Seat height in cm	45	45	
Powder-coated frame	round tube with platform	round tube with platform	
Weight	20 kg	22 kg	0.5 kg

OPTIONS	
Chrome-plated frame	■
Linking	■

POSITIONING OF CORNER/
EXTERNAL ELEMENTS

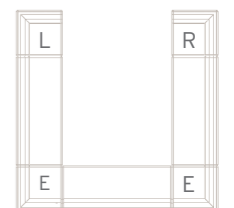

E = corner element
L = external element left
R = external element right



9385.001 DOMINO HOUSE
suitable addition to the DOMINO and MAZE Series

DOMINO SERIES | DOMINO HOUSE

- robust construction and durable foams
- frame powder-coated RAL 9006 chrome silver, optional chrome-plated
- height upholstered element with backrest: 74 cm
- upholstery element as well as interior and exterior walls optional with FLEECE, SKANDIA, TAFF B1 or WOOL fabric, for color selection see A2S material overview
- optionally available in 3 different colors within one fabric group: seating element, interior wall and exterior wall
- equipped with coat hooks left and right, powder-coated black



Up to 3 different colors selectable within one fabric group: Seating element, interior wall and exterior wall



Equipped with one coat hook each left and right

DOMINO HOUSE



MODEL	9385.001
Dimensions W/H/D in cm	170 x 165 x 72 cm
Seat height in cm	45
Powder-coated frame	skids
Weight	115 kg

OPTIONS

- Chrome-plated frame
- Felt floor protectors



The colorful seating elements **CYLINDA** and **BLOC** combine comfort with maximum flexibility, even in small rooms, and are ideal in combination with our DOMINO and MAZE Series, see page 131

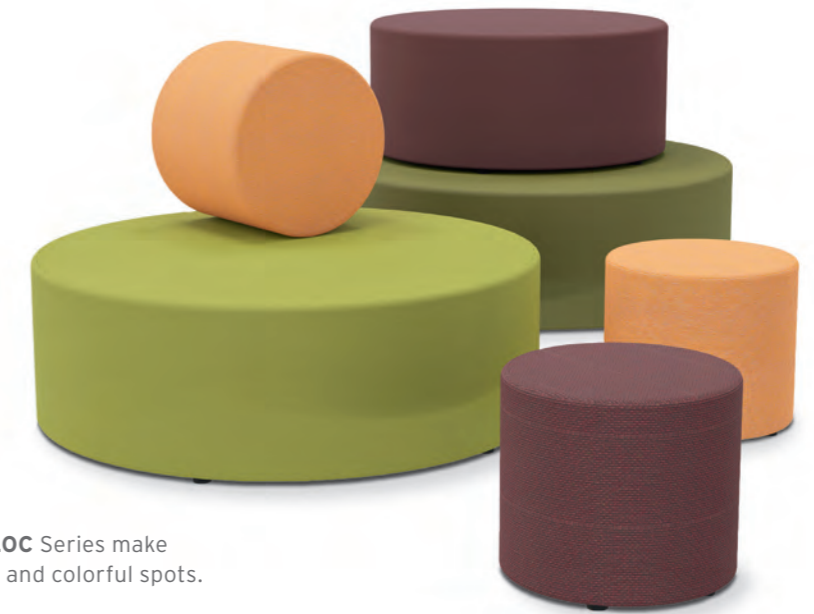

The seating islands of the **CYLINDA** and **BLOC** Series make diverse opportunities possible to place cosy and colorful spots.

CYLINDA AND BLOC SERIES | UPHOLSTERED STOOL



- robust construction and durable upholstery
- easy-care and hard-wearing upholstery fabrics and leather covers in a wide selection, in price group 1-4, see A2S material overview
- optional with hardly inflammable fabric and leather covers, in price group 2 and 4, see A2S material overview
- felt or plastic floor protectors

	CYLINDA			BLOC		
MODEL	9359.045	9359.090	9359.120	9358.042	9358.069	9358.096
Dimensions W/D in cm	Ø 45	Ø 90	Ø 120	42.5 x 42.5	69.5 x 42.5	96.5 x 42.5
Seat height in cm	41	41	41	41	41	41
Weight						

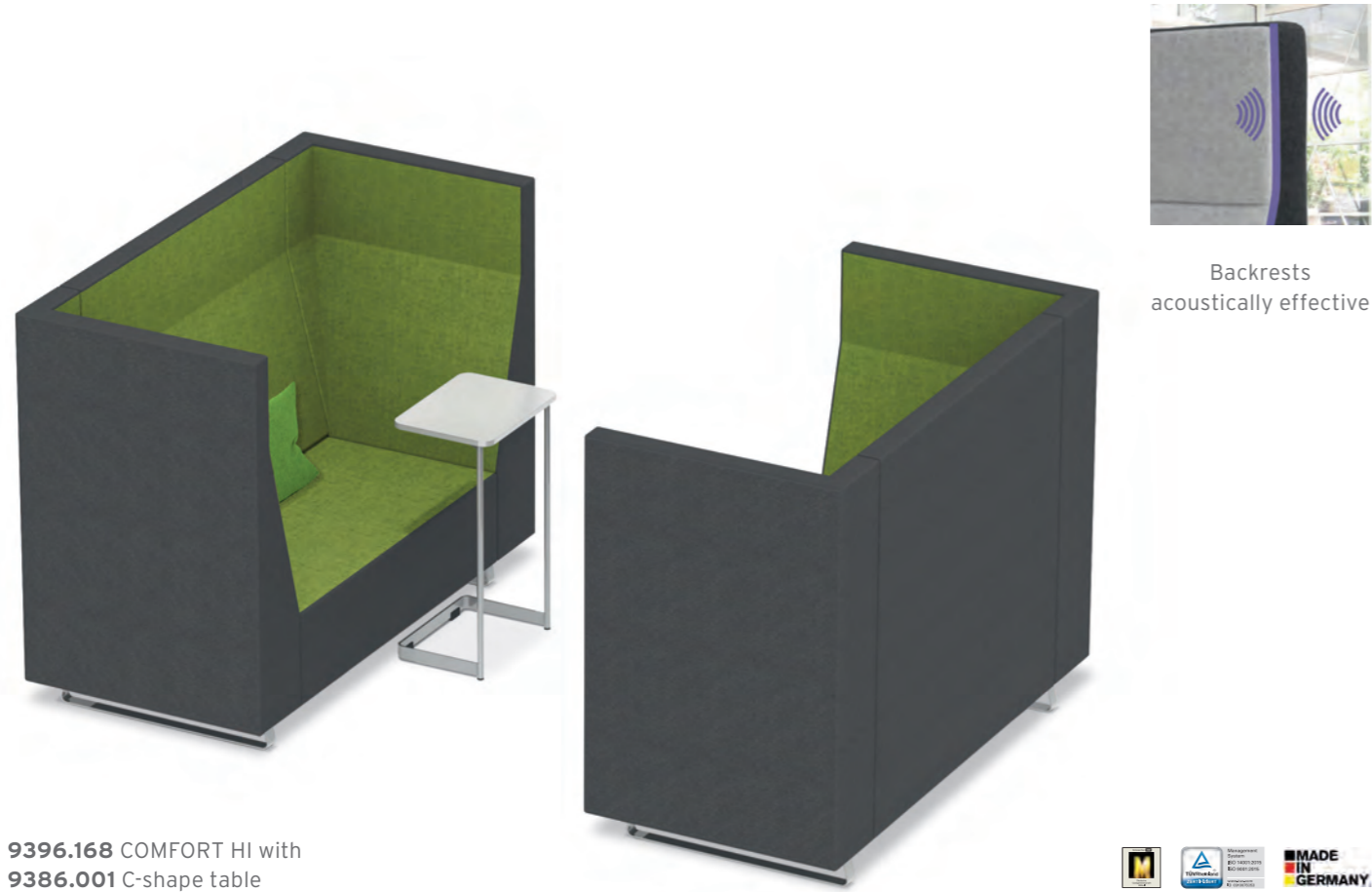

Backrests acoustically effective

9396.168 COMFORT HI with 9386.001 C-shape table







COMFORT SERIES | COMFORT HI

- flat skid frame optionally chrome-plated or powder-coated in RAL 9006 chrome silver
- robust construction and durable upholstery
- easy-care and hard-wearing fabrics and leather covers in the fabric groups 1-4 in a wide selection, see A2S material overview
- color combinations freely selectable within a fabric group
- optionally with hardly inflammable covers, B1 in price group 2 and 4, see A2S material overview
- COMFORT HI with high backrests is a room divider and absorbs sound

LOUNGE TABLES

- chrome-plated frame
- table top with multi-layer melamine resin coating, therefore scratch- and impact-resistant and glare-free
- as standard, we supply the table with a 3 mm plastic edge in the color of the table top, see A2S material overview
- optional edge with 40 mm corner radius

UPHOLSTERED FURNITURE COMFORT HI	1-SEATER	2-SEATER	3-SEATER	LOUNGE TABLES*	
					
MODEL	9396.105	9396.168	9396.223	9386.001	9386.137
Dimensions W/H/D in cm	106 x 131 x 82	169 x 131 x 82	224 x 131 x 82	46 x 73 x 34	130 x 54 x 70
Seat surface W/D in cm	57 x 59	120 x 59	175 x 59		
Seat height in cm	42	42	42		
Chrome-plated frame	flat skids	flat skids	flat skids	C-shape	flat skids
Frame RAL 9006	■	■	■	■	
Weight	64 kg	86 kg	108 kg	6 kg	26 kg

* more lounge tables can be found at the plate foot tables on page 77





Folding couch and armchair for sitting, lounging, sleeping - just in case

FOLDING ARMCHAIR AND COUCH

- a must for every all-day room with durable, 21 cm thick PUR foam core (hardness 35/45) - withstands even heavy use
- upholstery fabric TAFF B1 flame-resistant or PROTEX with antibacterial surface, water-repellent and easy to wipe off. Optional also with artificial leather, for colors see A2S material overview
- cover easy to remove through the zip and washable at 60 °C
- by folding out you get a lying surface of 180 x 176 cm (couch) or 80 x 180 cm (folding armchair)



5005.005 Folding armchair

	FOLDING ARMCHAIR	FOLDING COUCH
		
MODEL	5005.005	5005.001
Dimensions W/H/D in cm	80 x 71 x 80	180 x 71 x 88
Seat height in cm	42	42
Lying surface in cm	80 x 180 x 21	180 x 176 x 21
Weight	12 kg	30 kg



Our **CHILL** Series with beanbags, stools and floor cushions provides the necessary balance of comfort - because it is known that relaxed learning is the most effective way to learn.

CHILL SERIES | BEANBAGS/STOOL/CUSHION

- cover easily removable by zip
- fabrics washable or wipeable
- available in three different fabrics: OX, NORDIC or OUTSIDE, for color selection and material properties see A2S material overview
- beanbag with handle for easy carrying
- inner bag with safety zip
- filling of polystyrene beads, hardly inflammable, certified according to DIN 4102 B1
- beanbag in combination with stool to put up the feet
- stool and seat cushion not only for CHILL landscapes but also ideal for the seating circle

CHILL SERIES | SEAT CUSHION







- cover easily removable by zip
- fabrics washable or wipeable
- available in three different fabrics: OX, NORDIC or OUTSIDE, for color selection and material properties see A2S material overview
- foam core
- as upholstery for benches and also ideal for the seating circle on the floor



Whether the comfortable **beanbag** with handle for easy carrying, most appropriate in combination with one of the **stools** for the feet, or a cosy lounging area of large **couch cushions** - that's how easy it is to create little oases of well-being in everyday school life.

The particularly hard-wearing and waterproof fabric OX is recommended for primary school, which also matches the color scheme of the primary school very well.

For a more homely atmosphere and comfortable haptic, we recommend the fabric NORDIC, which can be easily integrated with the fabric groups 1-4 in thought out color concepts for secondary schools.

CHILL	BEANBAG	BEANBAG JUNIOR	STOOL	STOOL JUNIOR	COUCH CUSHION	SEAT CUSHION
						
MODEL	5030.045	5030.035	5033.040	5032.035	5031.001	5034.001
Dimensions W/H/D in cm	78 x 100 x 86	65 x 70 x 68	45 x 40 x 45	Ø 35 x 35	160 x 27 x 120	Ø 35 x 5
Seat height in cm	45	35	40	35	n.a.	5
Weight	5.5 kg	3.3 kg	2.5 kg	0.9 kg	7.9 kg	
Use	secondary schools	primary schools	secondary schools	primary schools	primary schools	primary schools



COMBI acoustic partition walls:
The right soundscape for healthy learning and working.

COMBI SERIES | ACOUSTIC PARTITION WALL

- acoustically effective honeycomb board as core
- available in the easy-care and hard-wearing fabrics TAFF B1 and WOOL, color selection see A2S material overview
- optional with electrical set with sockets, also available for retrofitting
- simple and versatile combinable system for all types of work
- flexible zoning and design of rooms and inviting relaxation areas
- levelling feet powder-coated RAL 9006 chrome silver, optionally also available with castors



Triangular table
1003.118
110 x 80 cm



Trapezoidal table
1004.147
140 x 70 cm



Classroom table
7210
70 x 55 cm



Group table
1001.088
80 x 80 cm



Group table
1001.077
70 x 70 cm

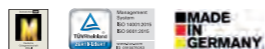

COMBI Acoustic movable walls in combination with **1004.147** trapezoidal tables for quiet working areas and **9387.147** MAZE as an island of rest



Up to four walls can be connected at different angles without tools.



powder-coated adjustable feet in chrome silver, optionally available with castors



COMBI ACOUSTIC PARTITION WALLS



MODEL	6710.070	6710.090
Dimensions W/D in cm	70 x 142 x 8	90 x 142 x 8
Weight	15 kg	19 kg

OPTIONS

Felt floor protectors	■	■
Castors	■	■
Electrical kit	6711.071	6711.091



6714.001/6714.002 Acoustic elements freestanding muffle noises, placeable in the room as required



Up to 5 pieces can be pushed into each other to save space

LEAF-SHAPED ACOUSTIC ELEMENTS

- acoustically effective fabric-coated chipboard with leaf shape
- available in the material groups FELT or WOOL, color selection see A2S material overview
- elements in different colors can be selected within a material group

FREESTANDING

- flexible zoning and pleasant design of rooms and relaxation areas depending on the situation
- for space-saving storage, can be pushed into each other up to max. 5 pieces

WALL-MOUNTED

- sets in two different sizes
- for wall mounting by means of a rail



6715.001/6715.002 The wall-mounted 3- and 5-part acoustic elements ensure pleasant acoustics and, thanks to their leaf shape, a natural atmosphere even during large meetings.

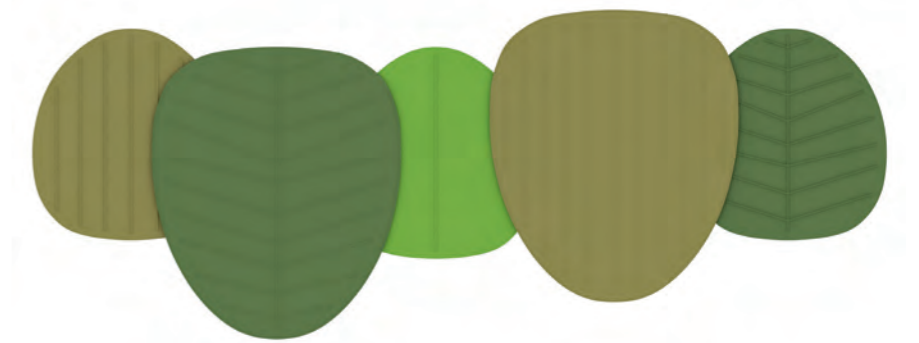

6715.001 Acoustic elements wall-mounted 5-piece set

ACOUSTIC ELEMENTS	FREESTANDING		WALL-MOUNTED	
MODEL	6714.001	6714.002	6715.001	6715.002
Dimensions W/H/D in cm	106 x 138.5 x 3/60	133 x 177.5 x 3/60	2 x: 106 x 113 x 3 1 x: 133 x 161 x 3	3 x: 106 x 113 x 3 2 x: 133 x 161 x 3
Frame powder-coated black	■	■		
Wall rail/overall length			2.6 m	4 m
Weight	16 kg	27 kg	41 kg	72 kg

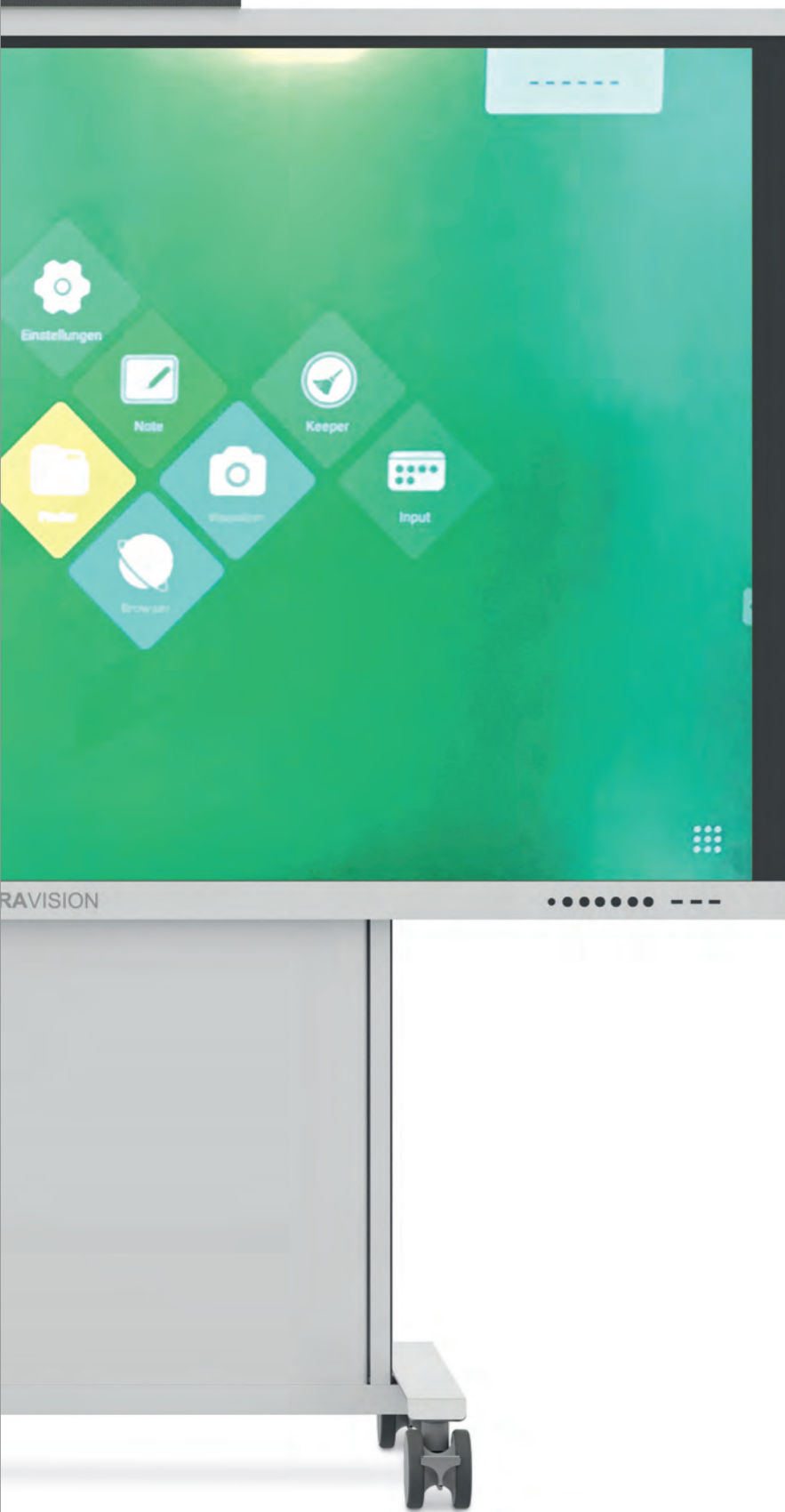

A2S BOARDS



Multifunctional board system 144



Display 146



Digital boards 148



Long wall boards 150



Sliding boards 151

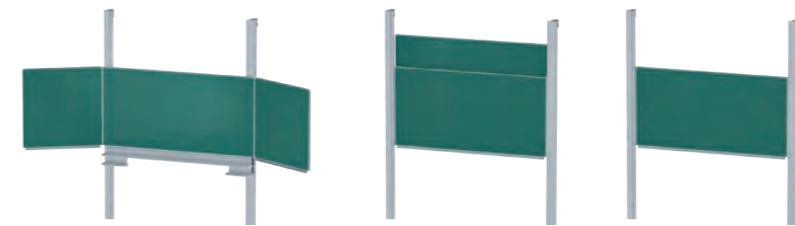

Pylon boards 152

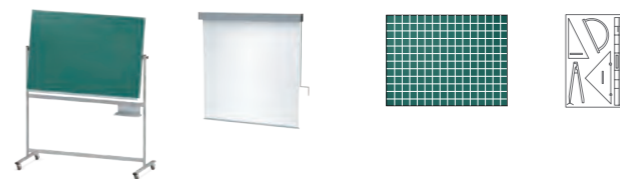

Bogie boards 154
 Light screens 154
 Rulings 155
 Accessories 155



White sheet steel magnetic for whiteboard pens

Green sheet steel magnetic for chalk

The boards can be used in portrait and landscape format (different rail spacing)

The boards can be removed from the rails: ideal for group work on the site

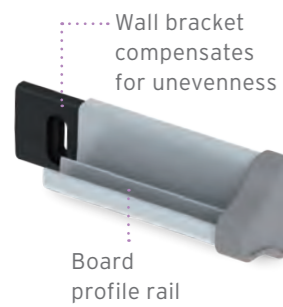

The A2S aluminium guide with robust plastic end caps is simply mounted on the wall bracket

MULTIFUNCTIONAL BOARD SYSTEM

- the board elements are particularly light and available in the sizes 90 x 60 cm and 120 x 80 cm
- the edging of the board elements is waterproof, the corners are rounded
- the working surfaces of the board elements in sandwich construction can be equipped as required, e.g. magnetic enamelled sheet steel in green or white
- the aluminium guide is robust, the fastening is invisible, the ends of the profile are enclosed by plastic caps
- board system can also be mounted on cabinet walls, info p. 109



The elastic ASSODUR® Edging strip protects the edges from impacts, e.g. when dropping



The lightweight board elements can be easily removed from the board profile rails, but are secured against accidental ejection



Sliding picture clamps with integrated gallery hook can be used in the upper aluminium guide

	SHEET STEEL GREEN		SHEET STEEL WHITE		SHEET STEEL GREEN/WHITE	
Dimensions	H 90	H 120	H 90	H 120	H 90	H 120
W 60 cm	6814 221		6814 321		6814 921	
W 80 cm		6814 223		6814 323		6814 923
OPTIONS						
Picture clamp (cannot be retrofitted)	■	■	■	■	■	■
Board profile rails 6872*	■	■	■	■	■	■

*Length individually adjustable, for exact planning please contact your A2S area manager



DVmobil
useable in different classrooms

DISPLAY | DURAVISION

- display made of tempered glass (ESG) glare-free with touch sensor
- resolution 3.840 x 2.160 pixels (UHD)
- display aspect ratio 16:9
- 2 integrated 12 W speakers
- integrated CPU: Android 5.1, Quad Core 450 MP, 2 GB RAM, 16 GB SSD, LAN, WIFI
- plug-in module, Wireless Mirroring Win, Mac, Android
- optional with plug-in PC and audio system



compatible with all operating systems



DVpylone
with two board wings writeable on both sides, adjustment range up to 140 cm, with integrated storage strip

DVcompact
height adjustable
optional with electrical height adjustment

DURAVISION	COMPACT	MOBIL	PYLONE
MODEL	DVcompact	DVmobil	DVpylone
Dimensions W/H/D	75" (176 x 103 x 10 cm) 86" (199 x 118 x 10 cm)	75" (176 x 103 x 10 cm) 86" (199 x 118 x 10 cm)	75" (176 x 103 x 10 cm) 86" (199 x 118 x 10 cm)
Design	wall-mounted height adjustable	mobile height adjustable	wall-mounted height adjustable lateral, foldable board wings with 4 writing surfaces pylon height 270 cm
Adjustment range	up to 60 cm	up to 60 cm	total pylon height
OPTIONS			
Plug-in PC	■	■	■
Audio system	■	■	■
Electrical height adjustment	■	■	

Bright ultra-short distance beamer for very good readability in all lighting conditions



Highly robust steel enamel surface for everyday school life. The sensor reacts pixel-precisely and without delay



Writing surface with rounded plastic "security corners"

Edges with aluminium profiles processed waterproof

Maintenance-free height adjustment, adjustment range: up to 70 cm

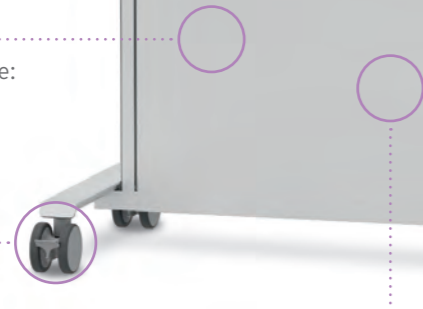

Firm stand due to heavy-duty castors, lockable in 2 positions



Storage strip integrated into the board, which keeps your hands free when needed

All electrical elements are safely stowed away; only the power supply cable is visible from outside

DBmobil
useable in different classrooms

DIGITAL BOARDS | DURABOARD

- system incl. whiteboard (200 x 120 cm) and ultra-short distance beamer
- optional with computer or audio system
- optional with remote control of the board via tablet
- for permanently mounted systems optionally with board wing
- intuitive to use



compatible with all operating systems



DBpylone
with two board wings writeable on both sides, adjustment range up to 140 cm



DBcompact
height adjustable, with integrated storage strip



The document camera (optional) transmits the image directly to the board



Optional with remote control of the board via tablet



The detection of pen movements is purely optical. No electromagnetic radiation, no exposure

DURABOARD	COMPACT	MOBILE	PYLONE
MODEL	DBcompact	DBmobil	DBpylone
Dimensions	200 x 120 cm	200 x 120 cm	200 x 120
Design	wall-mounted height adjustable	mobile height adjustable	wall-mounted height adjustable folding side wings
Adjustment range	up to 70 cm	up to 70 cm	up to 140 cm
optional: Board wings (except mobile board), audio system, integrated computer, software			

BOARD ACCESSORIES
Audio system, response system, tablet and document camera complement the digital board system and expand the possibilities for use and learning.

Ask your A2S field service.



Long wall board Magnetic sheet steel green
Ruling optional, see page 155



Available in 4 different surfaces



Picture clamping strip optional



Writing surface with rounded "safety corners";
profile covers firmly screwed on

LONG WALLBOARDS

- for wall mounting with and without storage strip
- due to the sandwich construction different surfaces are possible
 - enamelled, magnetic steel sheet in green or white
 - 4 mm thick cork coating
 - 6 mm thick cork linoleum coating in 4 different colors, see A2S material overview
- the edges of the writing surfaces are glued waterproof with natural anodised aluminium profiles
- the corners are protected with rounded plastic caps

Dimensions	SHEET STEEL GREEN			SHEET STEEL WHITE			CORK COATING		CORK LINOLEUM COATING	
	H 100	H 120	H 150	H 100	H 120	H 150	H 100	H 120	H 100	H 120
W 100 cm	6810 201			6820 301			6830 501		6815 401	
W 120 cm	6810 202			6820 302			6830 502		6815 402	
W 150 cm	6810 203	6810 204		6820 303	6820 304		6830 503	6830 504	6815 403	6815 404
W 200 cm	6810 205	6810 206		6820 305	6820 306		6830 505	6830 506	6815 405	6815 406
W 250 cm	6810 207	6810 208		6820 307	6820 308		6830 507	6830 508	6815 407	6815 408
W 300 cm	6810 209	6810 210	6810 213	6820 309	6820 310	6820 313	6830 509	6830 510	6815 409	6815 410

OPTIONS											
Storage strip	incl.	incl.	incl.	■	■	■	■	■	■	■	■
Picture clamping strip	■	■	■	■	■	■	■	■	■	■	■



Stop of end position by metal springs with rubber buffer



Hinged sliding board floor/wall mounting



Hinged sliding board wall mounting



Single surface sliding board

ATTENTION!
Wall mounting of long wall or hinged sliding boards is only possible with solid walls; with lightweight walls only with load distribution frames.

SLIDING BOARDS

- robust welded steel construction, scratch-resistant powder-coated
- maintenance-free, low-noise precision guide on 8 polyamide rollers with ball bearings
- aluminium guide rail
- sprung steel counterweights
- incl. storage strip and sponge container

SINGLE SURFACE SLIDINGBOARD | FLOOR/WALL MOUNTING

Dimensions	SHEET STEEL GREEN			SHEET STEEL WHITE		
	H 100	H 120	H 150	H 100	H 120	H 150
W 200 cm	6843 205	6843 206	6843 211	6843 305	6843 306	6843 311
W 250 cm	6843 207	6843 208	6843 212	6843 307	6843 308	6843 312
W 300 cm	6843 209	6843 210	6843 213	6843 309	6843 310	6843 313

optional: mobile version, free-standing version, floor mounting

HINGED SLIDINGBOARDS | FLOOR/WALL MOUNTING

Dimensions	SHEET STEEL GREEN			SHEET STEEL WHITE		
	H 100	H 120	H 150	H 100	H 120	H 150
W 200 cm	6840 205	6840 206	6840 211	6840 305	6840 306	6840 311
W 250 cm	6840 207	6840 208		6840 307	6840 308	

optional: mobile version, free-standing version, floor mounting

HINGED SLIDINGBOARDS | WALL MOUNTING

SHEET STEEL GREEN			SHEET STEEL WHITE		
H 100	H 120	H 150	H 100	H 120	H 150
6841 205	6841 206	6841 211	6841 305	6841 306	6841 311
6841 207	6841 208		6841 307	6841 308	

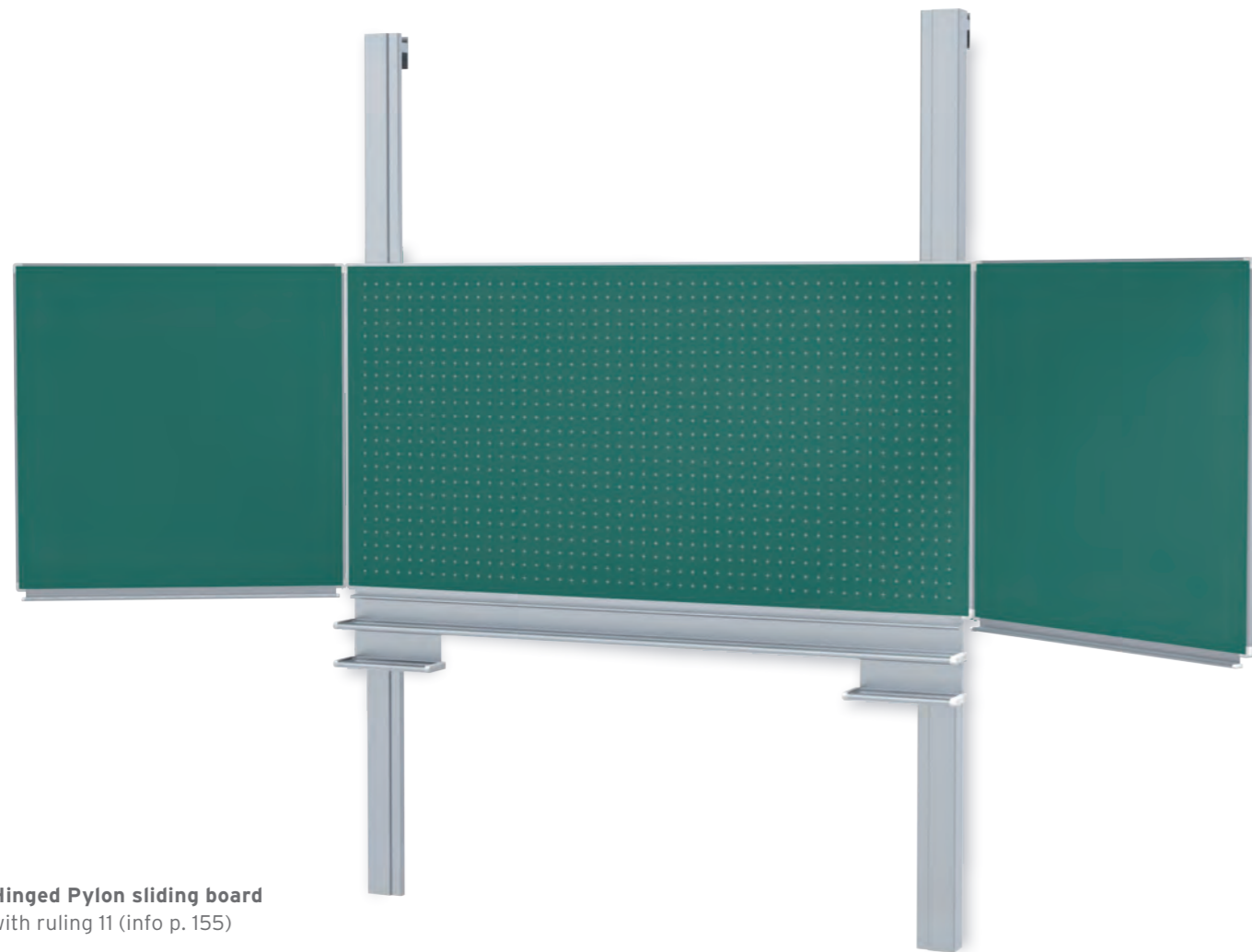

Hinged Pylon sliding board
with ruling 11 (info p. 155)

PYLON BOARDS

- robust aluminium column guide, wall mounting
- maintenance-free and low-noise precision guide on 8 polyamide rollers with ball bearing
- incl. storage strip and sponge container
- working surface made of enamelled, magnetic sheet steel in green or white
- waterproof processed edge trim with rounded corners
- rulings optional for green or white board surfaces

HINGED PYLON SLIDING BOARD

	SHEET STEEL GREEN			SHEET STEEL WHITE		
Dimensions	H 100	H 120	H 150	H 100	H 120	H 150
W 200 cm	6850 205	6850 206	6850 211	6850 305	6850 306	6850 311
W 250 cm	6850 207	6850 208		6850 307	6850 308	

incl. storage strip and sponge container



Pylon double sliding board
incl. storage strip and sponge container
for wall mounting



Pylon single-surface sliding board
incl. storage strip and sponge container
for wall mounting



Storage strip and sponge container



Rulings optional for green or white boards (info p. 155)



The accessories adhere magnetically to the sheet steel board surface

PYLON DOUBLE SLIDING BOARD

	SHEET STEEL GREEN			SHEET STEEL WHITE			SHEET STEEL GREEN			SHEET STEEL WHITE		
Dimensions	H 100	H 120	H 150	H 100	H 120	H 150	H 100	H 120	H 150	H 100	H 120	H 150
W 200 cm	6854 205	6854 206	6854 211	6854 305	6854 306	6854 311	6853 205	6853 206	6853 211	6853 305	6853 306	6853 311
W 250 cm	6854 207	6854 208	6854 212	6854 307	6854 308	6854 312	6853 207	6853 208	6853 212	6853 307	6853 308	6853 312
W 300 cm	6854 209	6854 210	6854 213	6854 309	6854 310	6854 313	6853 209	6853 210	6853 213	6853 309	6853 310	6853 313
W 400 cm	6854 214	6854 215	6854 216	6854 314	6854 315	6854 316	6853 214	6853 215	6853 216	6853 314	6853 315	6853 316

incl. storage strip and sponge container



Magnetic writing surface can be rotated 360° and locked



Connecting rod removable, alternatively available with electric motor

BOGIE BOARDS

- with mobile, stable tubular steel frame and 4 swivel castors, universally applicable
- the 360° horizontally rotating writing surface can be locked in any position and is magnetic
- edges waterproof processed
- incl. storage strip and sponge container
- rulings optional

6855 SERIES

	SHEET STEEL GREEN		SHEET STEEL WHITE	
Dimensions	H 100	H 120	H 100	H 120
W 120 cm	6855 202		6855 302	
W 150 cm	6855 203	6855 204	6855 303	6855 304
W 200 cm	6855 205	6855 206	6855 305	6855 306

incl. storage strip and sponge container

SCREENS

- structured, matt white surface; cloth type D according to DIN 19045
- housing made of square sheet steel RAL 9003
- removable connection rod
- also with electric motor in noise-insulated construction with automatic limit stop against moving the screen too far out

6880 AND 6890 SERIES

	CONNECTING ROD	ELECTRIC MOTOR
W 200 x H 200 cm	6882	6892
W 300 x H 250 cm		6895
W 300 x H 300 cm	6886	

RULINGS

- all rulings are possible on green, enamelled writing surface as well as on frosted glass inlay wings
- selected rulings on **white enamel steel** up to board size 300 x 120 cm possible

1. SCHOOL YEAR	2. SCHOOL YEAR	3. SCHOOL YEAR	4. SCHOOL YEAR	4. SCHOOL YEAR
RULING 01 Distance: 4 5 4 cm	RULING 02 Distance: 3 4 3 cm	RULING 03 Distance: 3.5 8 cm	RULING 04 Distance: 10 cm also on steel enamel white	RULING 08 Distance: 8 cm
CALCULATION BOX	CALCULATION BOX	CALCULATION BOX	CROSS CHECK	CROSS CHECK
RULING 05 Distance: 5 cm also on steel enamel white	RULING 07* Distance: 7 cm	RULING 10 Distance: 10 cm also on steel enamel white	RULING 11 Distance: 5 cm also on steel enamel white	RULING 12 Distance: 10 cm also on steel enamel white
SHORTHAND LINES	NOTE LINES	NOTE LINES	*Ruling 07 not available with white frosted glass inlay board	
RULING 14 Distance: 4 cm	RULING 15 Distance: 2.5 cm also on steel enamel white	RULING 16 Distance: 5 cm		

ACCESSORIES

PICTURE CLAMPING STRIP	PICTURE CLAMP	BOARD WIPER	WIPING FELTS	DRAWING SETS		
6865	6860	509261	509296	6862 4-piece: ruler, compass, set-square 60 cm, pointer, instrument board, magnetic	6863 4-piece: ruler, compass, set-square 80 cm, pointer, instrument board, magnetic	6869 6-piece: ruler, compass, angle 45°, angle 30°, protractor, pointer, instrument board, magnetic
BOARD PEN HOLDER	BOARD PEN	PIN SET	HOLDING MAGNETS	POWER MAGNETS		
509303	509304	509260	509306	509307		



A2S FINISH BOARDS

When pupils are letting off steam, the tables at which they sit should be particularly resistant to abrasion, scratches and shocks. That's exactly why we have covered all our tabletops, which are made of chipboard with A2S standard finishes, in several layers with a robust melamine resin coating.

This means that school furniture not only survives the rough every-day school life, it is also easy to clean and largely glare-free.



WOODMARK

Our tabletops are subjected to a lot of wear and tear every day. That's why we provide them with a lot for their journey through life. Special resins ensure break-proof quality of our MDF carrier boards. Under high pressure and heat we press the upper and lower cover layer of hard-wearing, melamine resin-coated finish layer with the board in a metal mould. This makes Woodmark surfaces particularly resistant to abrasion, scratches and impacts.

They are glare-free and easy to clean. Rounded edges reduce the risk of injury.



COMPACT BOARD

The compact board is a highly compressed, black colored wood fibre board. The natural material wood is gently defibered during production and further processed according to ecological aspects. The board has a very high density and is therefore, despite its slim design (thickness 12 mm), extremely robust and the edges are particularly resistant.

MULTIPLEX

Multiplex is, as a material made of cross-glued solid veneers, very dimensionally stable and resilient. For our table tops we coat the robust core made of solid beech multiplex on both sides with 0.8 mm thick HPL laminate, which is abrasion-, scratch- and impact-resistant. In addition it is fire-retardant, food-safe and environmentally friendly, thanks to renewable raw materials. Soft rounded edges make the table tops less susceptible to possible damage and reduce the risk of injury.





PLASTIC EDGE

The plastic edge is robust and shock-proof. As standard, these plastic edges are manufactured in a color matching the surface finish. These edges are ideally suited for table tops in administrative areas.



1 mm square edge
(corpus furniture)

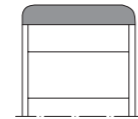

3 mm edge rounded off
(front panels of corpus furniture and table tops)

SOLID WOOD EDGES

A2S solid wood edges are firmly glued to the chipboard, have a high-quality appearance and protect the stressed furniture edges. We offer our concealed edges for the highest demands - in this case the chipboard is additionally coated on both sides with a 0.8 mm thick HPL board. This abrasion-, scratch-resistant and shock-proof HPL coating is fire-retardant, food-safe and, thanks to renewable raw materials, environmentally friendly.



Concealed edge
band crowned



ASSODUR® EDGE

For the ASSODUR® edge, the elastic and liquid polyurethane edge is cast onto the table edge in a metal mould. Due to the strong cross-linking with the board material, it is thus particularly permanently bonded to the chipboard. The ASSODUR® edges are available in three color combinations, all free of PVC and especially abrasion- and impact-resistant.

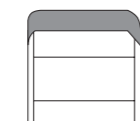

PAGHOLZ®

Wherever furniture is subject to particularly heavy use, we rely on PAGHOLZ®, an invention from our company. For PAGHOLZ®, thin veneer layers are prepared at great expense, individually stained and soaked in synthetic resin. Only then we press them under heat with up to 2,000 tons of pressure into the desired shape.

PAGHOLZ® offers the natural appearance of solid wood and much more:

- high form stability
- high scratch and wear resistance
- shock and break resistance
- resistance to staining and abrasion
- light fastness and resistance to chemicals

For you, this means: easy cleaning and flame-resistant, self-extinguishing material that is even weatherproof with special resins on request.

You can be sure of that: We only use native red beech from tree stocks that are carefully reforested. And of course all products made of PAGHOLZ® are particularly durable and can be recycled.



Resistant to
chemicals



Stain- and
abrasion-resistant



Hardly inflammable,
self-extinguishing



Scratch- and
wear-resistant



Shock- and
break-proof

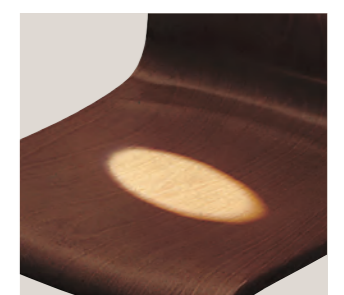

Lightfast

ADVICE

We advise you on site.



INSTALLATION

Our fitters set up fully assembled furniture without disrupting school operations.

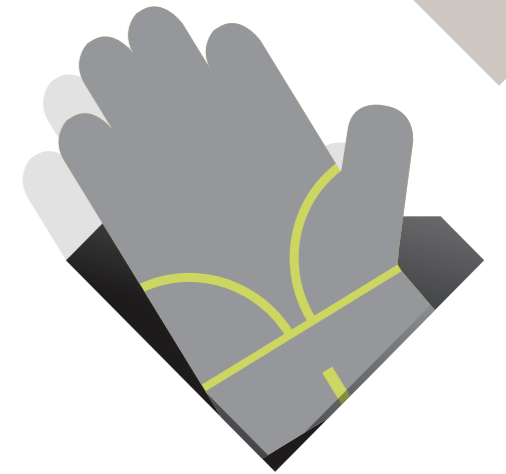

PLANNING

Design of your rooms on request, including color and furnishing concept in accordance with the legally required standards.



PACKAGING

We take all packaging with us for disposal, you just need to arrange the furniture.



VISUALISATION

Detailed renderings provide more planning security.

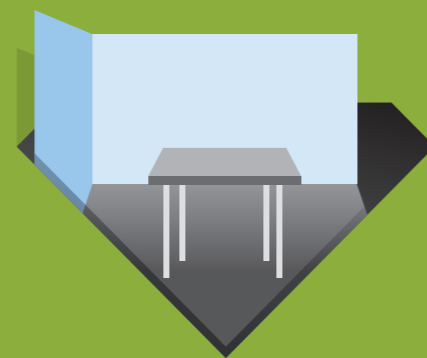

SPARE PARTS

Even after years you can obtain spare parts quickly and without bureaucracy directly from www.a2s.com/service service@a2s.com

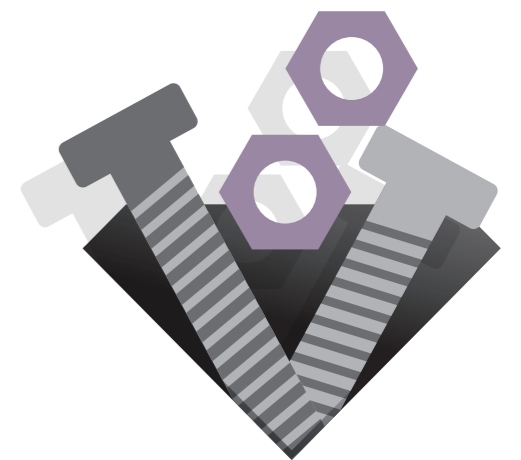

ON-SITE SERVICE

All the furniture is assembled where you want it.



REPAIR

In case of larger damages our repair service takes care of the issue.



A
 Acoustic movable walls138 f., 140 f.
 Acoustic elements 140 f.
 Accessories boards 155
 Accessories classroom tables59
 Accessories table systems89
 Armchair 135
 Armrest (chairs with) 22 f., 26 f., 28ff.
 Assembly service 160 f.
 ASSODUR® edge, material science 158

B
 Bag shelves115
 Bar stools15, 38 f., 41
 Base units 109, 125
 Beanbag136 ff.
 Benches 36 f.
 BLOC Series 133
 Board accessories 155
 Board rulings 155
 Boards142 ff.
 Board system 144 f.
 Bogie boards154
 Book storage for classroom tables59
 Book shelves114
 Book trolley114

C
 C-shaped frame (chairs with) 12 ff.
 Cabinets for musical instruments116
 Cabinets individual 98 f.
 Cable clamp89
 Cable channel89
 Cable conduit89
 Cable outlet89
 Cantilever chairs23, 31 f.
 Castors 70, 89
 Certificates 3
 Chairs10 ff.
 Chairs with armrests 22 f., 26 f., 28ff.
 Chairs with C-shaped frame 12 ff.
 Chairs with four-leg frame12 ff., 22 ff., 30 ff.
 Chairs with plastic shell 12 f., 20f.
 Chairs with writing surface 12 ff., 20 f.
 Chairs with Z-shaped frame12 f.
 CHANGE Series18f., 38, 110 ff.
 Circular segment shelf114
 Clamping rails152 f.
 Classroom cabinets 115 f.
 Classroom chairs 12 ff.
 Classroom tables 44 ff.
 COMFORT Series 134
 Compact board, material science 156
 Computer tables 66 ff.
 Conference chairs 30 ff.
 Conference tables78 ff.
 Containers92 ff.

Corpus furniture97 ff.
 CPU holder 70, 89
 Cushion136 f.
 Cushion combination130 f.
 CYLINDA Series 133

D
 Development 4 f.
 Desk systems78 ff.
 Digital boards 148 f.
 Display cases 122
 DOMINO Series130 ff.
 DOMINO HOUSE 132
 Drawing cabinets116
 Drawing devices (boards) 155
 Drawing tables59

E
 Electrically height-adjustable tables 60 f.
 Elements acoustic138 ff.

F
 Filing shelves/cabinets103 f.
 Finish boards, material science156
 Fixed castor89
 FLEX5, 12 f.
 Floor cushions136 f.
 Folding sliding boards 151 f.
 Folding tables72 ff.
 Folding table transport trolley 73
 Four-legged frame (chairs with)12 ff., 22 ff., 30 ff.
 Four-legged stool34 f., 39
 Freeform table systems 83 f.

G
 Gas-lift chairs12 ff., 20 ff., 28 ff.

H
 Hallway furniture system118 f.
 Height-adjustable stools34 f., 39
 Height-adjustable student chairs12 ff., 20 f.
 Height-adjustable student desks 55 ff.
 High tables39, 60 ff., 77

I
 Information display cases 122
 Interactive boards146 ff.
 IT tables 66 f.

L
 Large capacity chairs 22 ff.
 Laptop cabinet 116
 Light screens154
 Line marking (boards) 155
 Long wall boards150
 Lounge tables77, 134

M
 Material boxes 120
 Mats136 f.
 MAZE Series130 f.
 Media workstations 108 f.
 Meeting tables76 ff.
 Mobile boards144 f., 146, 148, 154
 Mono-column tables 62 f.
 Mounting tables78 ff.
 Multifunctional board system 109, 144 f.
 Multiplex shells, chairs20 ff., 34 ff.
 Multiplex, materials science 157
 Multi-purpose chairs 22 f.
 Music cabinets 116

O
 Odds and ends box121
 On-site service 160 f.
 Office desks 62 f., 78 f.
 Office swivel chairs28 ff.
 OFFICE tables 60 f.
 Open shelves102 f.

P
 PAGHOLZ®, materials science 159
 PAGHOLZ® shell (chairs with)14 ff., 30 f., 34 f., 38
 Painting and drawing tables59
 Pharmacy cabinets 94 f.
 Pin boards 90 f., 150 f.
 Plastic boxes 120
 Plastic edge, material science 158
 Plastic shell (chairs with) 12 f., 20f.
 Plastic stool35
 Plate base tables 77
 Privacy screens 90 f., 138 f.
 Property shelves/cupboards115, 120
 Property trolley115
 Pylon boards152 f.

Q
 Quality 2 f.
 Quarter circle shelf114

R
 Rail system, boards 144 f.
 Roller shutter cabinets 107
 Rolling containers 92 f.
 Room dividers 110 f., 114 ff., 123
 Round tables63, 77, 83 f.

S
 S-shaped tables85
 School bag shelves115
 Seat combinations130 f.
 Segment shelf114
 Segment tables 80 ff.

Semicircular tables 84, 87
 Shelves102 f., 114 f., 117
 Sideboards 110 ff.
 Side folding tables 70 f.
 Single surface sliding boards 150
 Single boards 144 f.
 Size table 8 f.
 Skid-base chairs14, 17, 20 f., 27
 Sliding board system 109, 144 f.
 Sliding door cabinets 106, 122
 Sofas 135
 Solid wood chairs 26 f.
 Solid wood tables 86 f.
 Sound insulation 90 f.
 Specialist room tables 58 f.
 Stacking benches 36 f.
 Stacking chairs 12 ff., 31 ff.
 Stacking tables 44 f., 72 f., 84 f.
 Stacking trolley 32, 73 f.
 Standing/sitting workstation 60 f.
 Stool 15, 34 f., 39, 41, 133
 Storage boxes120 f.
 Student chairs 12 ff.
 Student chairs, height-adjustable 12 ff., 20 f.
 Suspension containers93

Steel shelves114
 Suspension file for containers 93
 Swivel castor70
 Swivel spindle chairs 12 ff., 21
 Swivel stool34 f., 39
 Swivel work chairs12 ff., 20 ff., 28 ff.

T
 T-shaped tables52 ff.
 Table attachments80
 Table combinations78 ff.
 Table partition wall system 90 f.
 Tables42 ff.
 Tables, electrically height-adjustable 60 f.
 Table systems78 ff.
 Teacher's cabinets124 f.
 Teacher's desks 64 f.
 Tidy Boxes 120
 Top-mounted cabinets102, 104 ff., 118 f.
 Transport trolley 32, 73 f.
 Trapezoidal tables83 f., 87
 Triangular tables 83 f.

U
 Upholstered furniture129 ff.

Upholstered house128 f.
 Upholstered stool 133

V
 Visualization on computer 160 f.

W
 Wall boards 144 f., 150
 Wall board system 144 f.
 Wall rail system 144 f.
 Wardrobe cabinets117
 Waved tables84
 WAVE office chairs 30 f.
 Whiteboard sliding door cabinet 109
 Wooden chairs 26 f.
 Wooden frame (tables with)50 f., 65, 86 f.
 WOODMARK, materials science 157
 Work stools 34 f.
 Writing surface (chairs with) 12 ff., 20 f.

Z
 Z-shaped frame (chairs with)12 f.

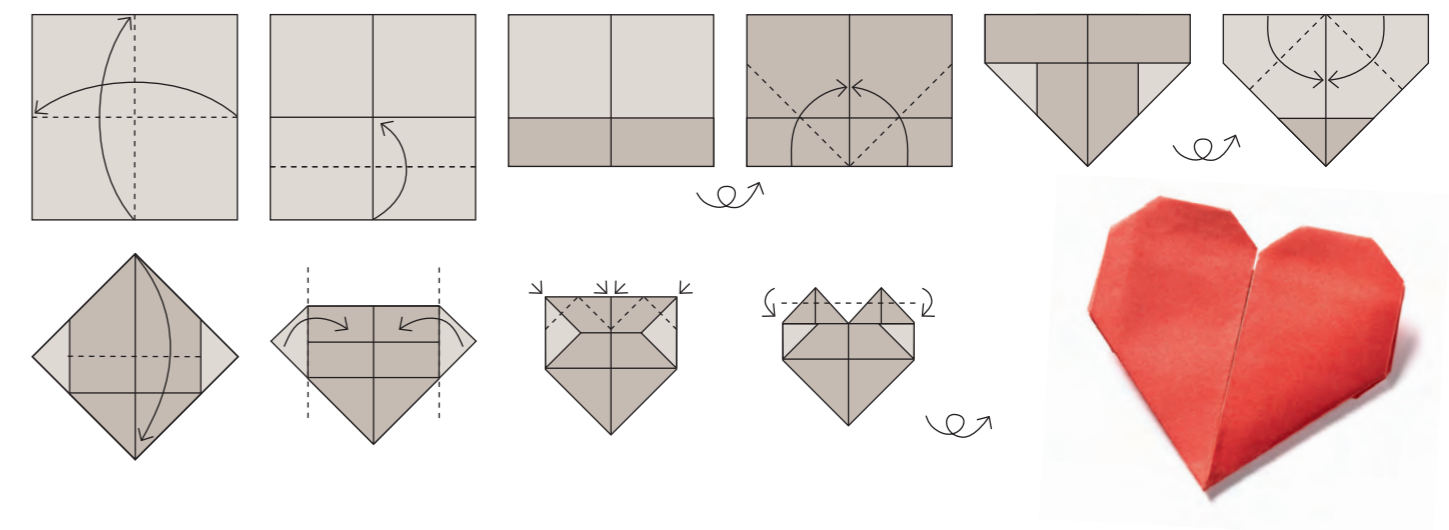

SPACE FOR YOUR IDEAS

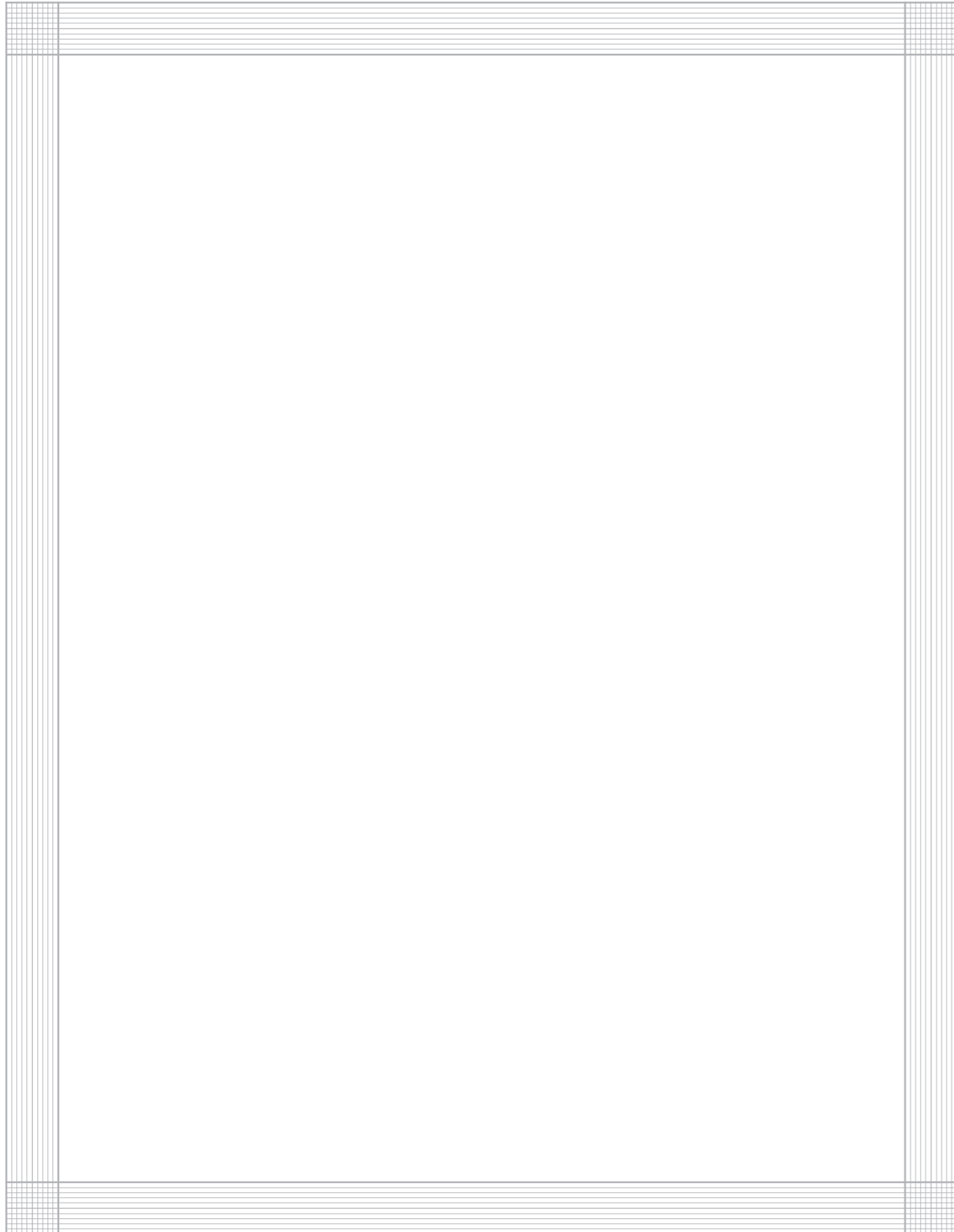

CONTACT

YOUR CONTACTS IN SALES

A2S-Furnishing Systems
ASS-Einrichtungssysteme GmbH
ASS-Adam-Stegner-Straße 19
96342 Stockheim
Germany
Phone +49 9265 808-0
Fax +49 9265 808-201
Email info@a2s.com



DER BILDUNGSEINRICHTER.

WWW.A2S.COM