



tec2SKILL®

INSPIRING TECHNOLOGIES

Pneumatics, Electropneumatics, Planetary and Worm Gears
Digitize Your Education Concept



PNEUMATICS/ELECTROPNEUMATICS

tec2SKILL®

Hardware



How to obtain the tec2SKILL App?

Simply search for „tec2SKILL“ in your App-Store.

The QR codes on the right will get you there directly.

Please scan the QR-code and install the demonstration-app.

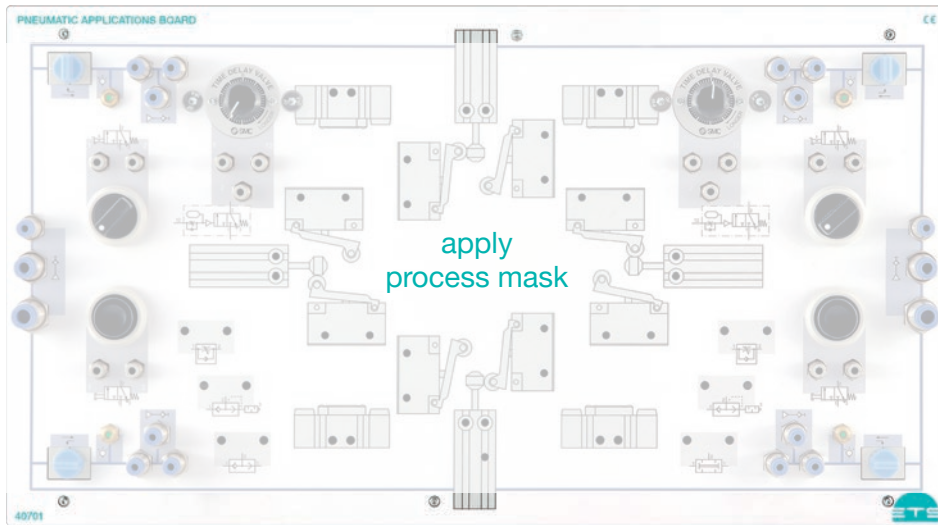

40701

Pneumatic Application Board



40700 Pneum. Supply Board

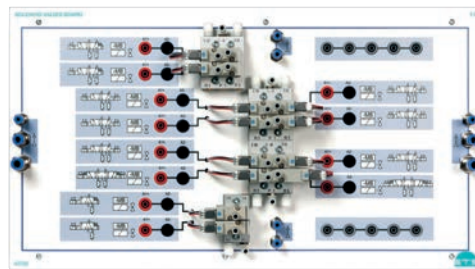

40702

Solenoid Valves Board

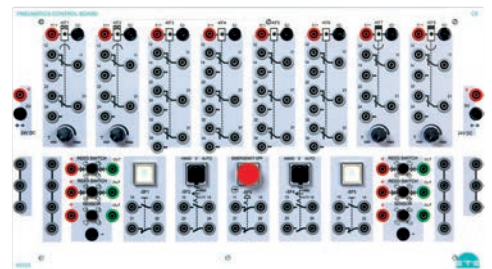

40703

Pneumatics Control Board

Courseware

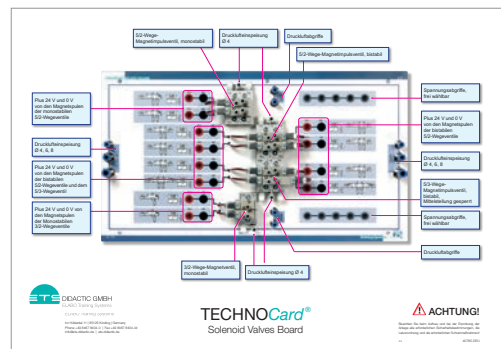
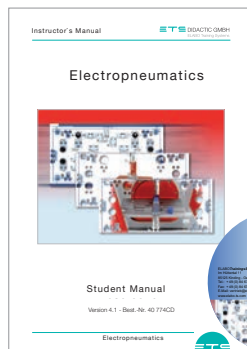
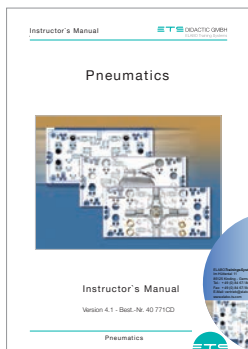

PROCESS ANIMATION

Pneumatics

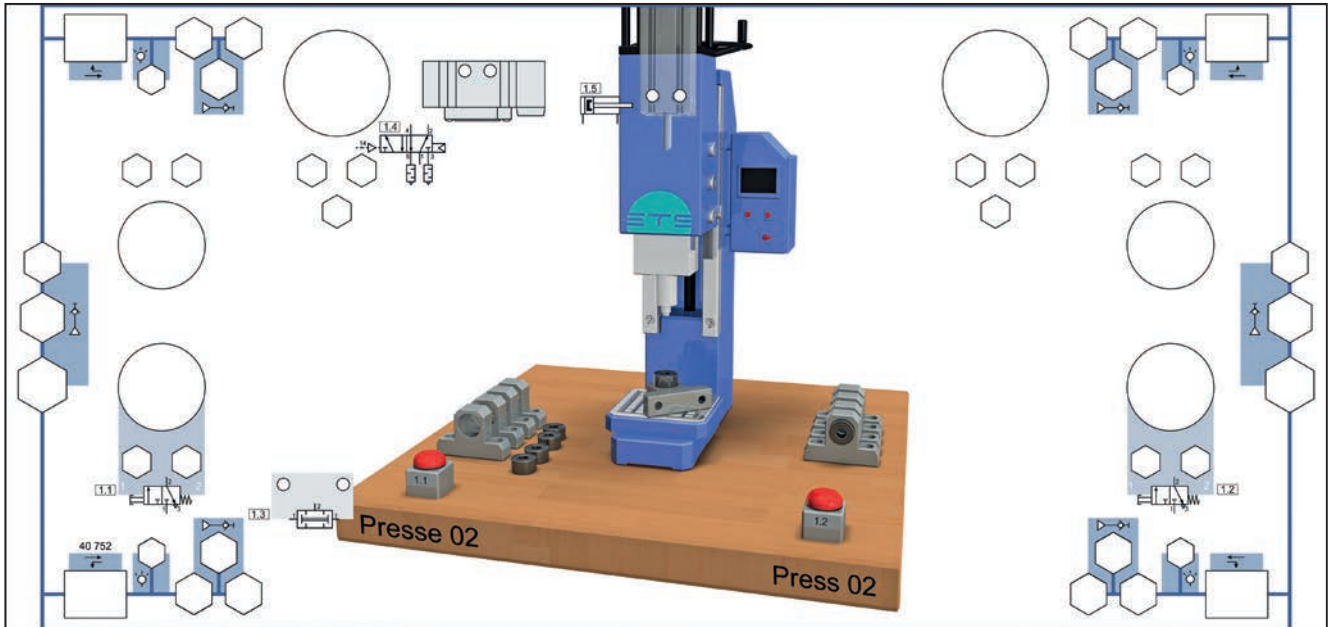

Electropneumatics

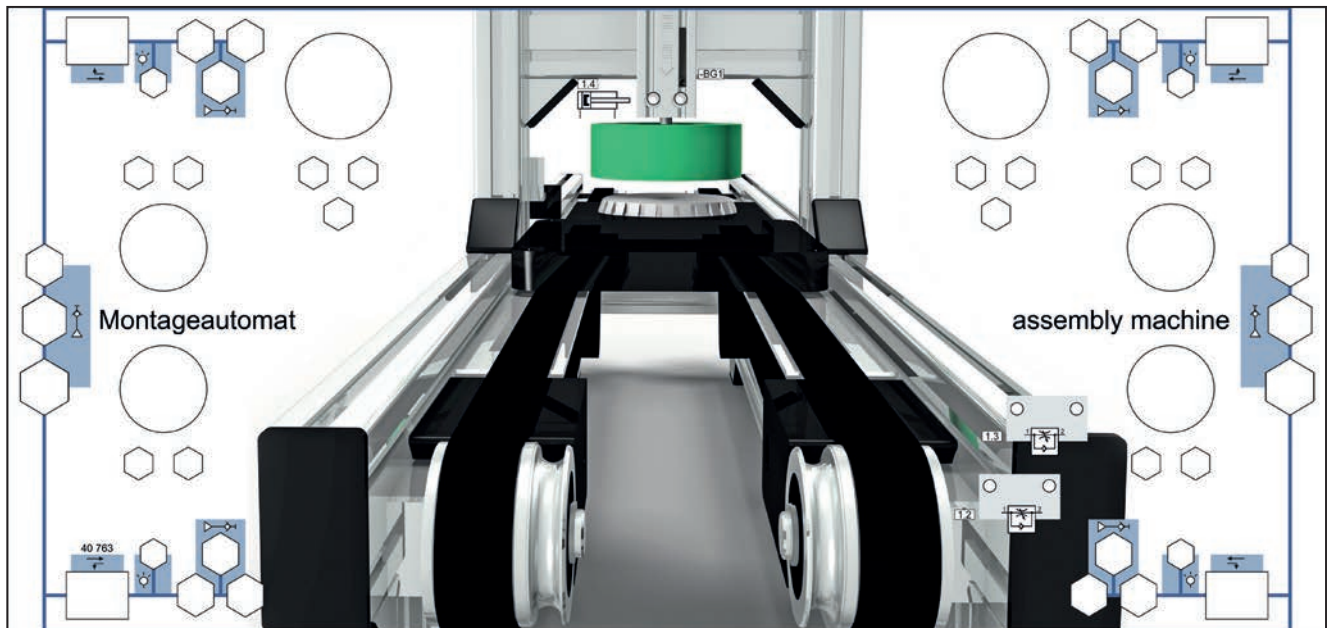

SENSORICS BASICS

tec2SKILL®

Digital Sensorics | Analogue Sensorics | IO-Link



The digital learning assistant in sensorics

With augmented reality tec2SKILL® assists the learner to gather helpful informations. The functionality of the real industrial application, data sheets or references for the implementing, complete the learning situation.

1. apply process mask

2. Scan with APP

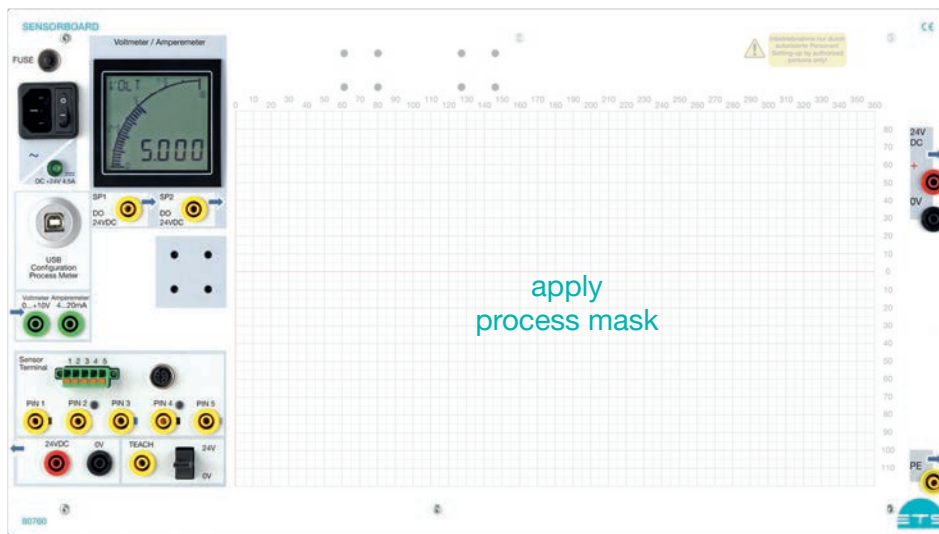

80760

Sensor Board

Courseware

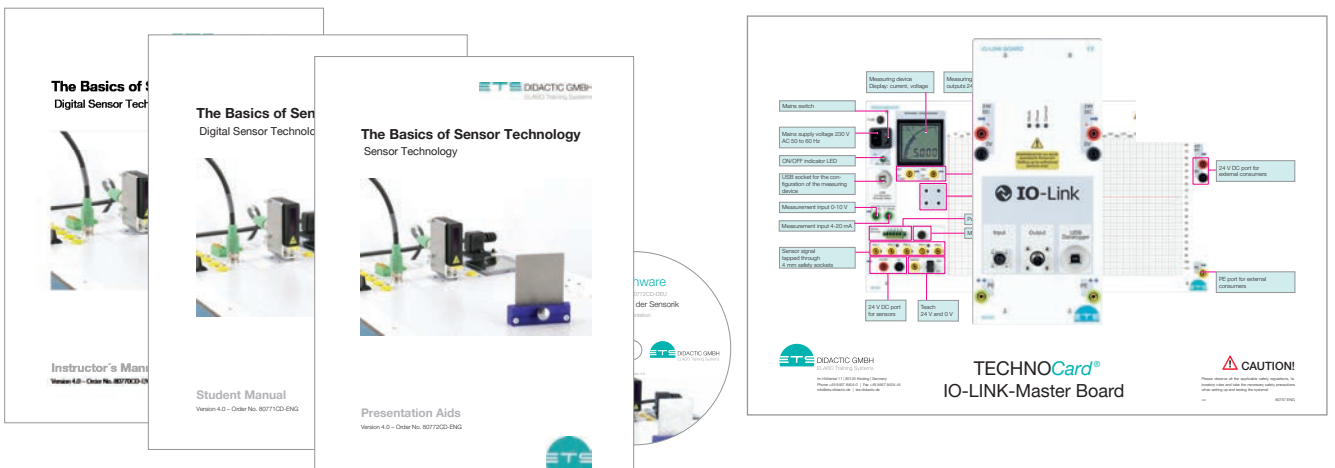

Description	Ordner No.	Description	Order No.
TECHNOCard® – Sensor Board	80767-ENG	Basics Sensorics IO-Link, Instructor's Manual	80796CD-ENG
Basics Sensorics – Digitalsensorics, Instructor's Manual	80770CD-ENG	Basics Sensorics IO-Link, Student Manual	80797CD-ENG
Basics Sensorics – Digitalsensorics, Student Manual	80771CD-ENG	GBasics Sensorics - cylinder sensors, Instructor's Manual	80745CD-ENG
Basics Sensorics, Presentation Aids	80772CD-ENG	Basics Sensorics - cylinder sensors, Student Manual	80746CD-ENG
Basics Sensorics Analogue, Instructor's Manual	80793CD-ENG	Basics Sensorics measuring resistor PT100, Instructor's Ed.	80791CD-ENG
Basics Sensorics Analog, Student Manual	80794CD-ENG	Basics Sensorics measuring resistor PT100, Student Ed.	80792CD-ENG

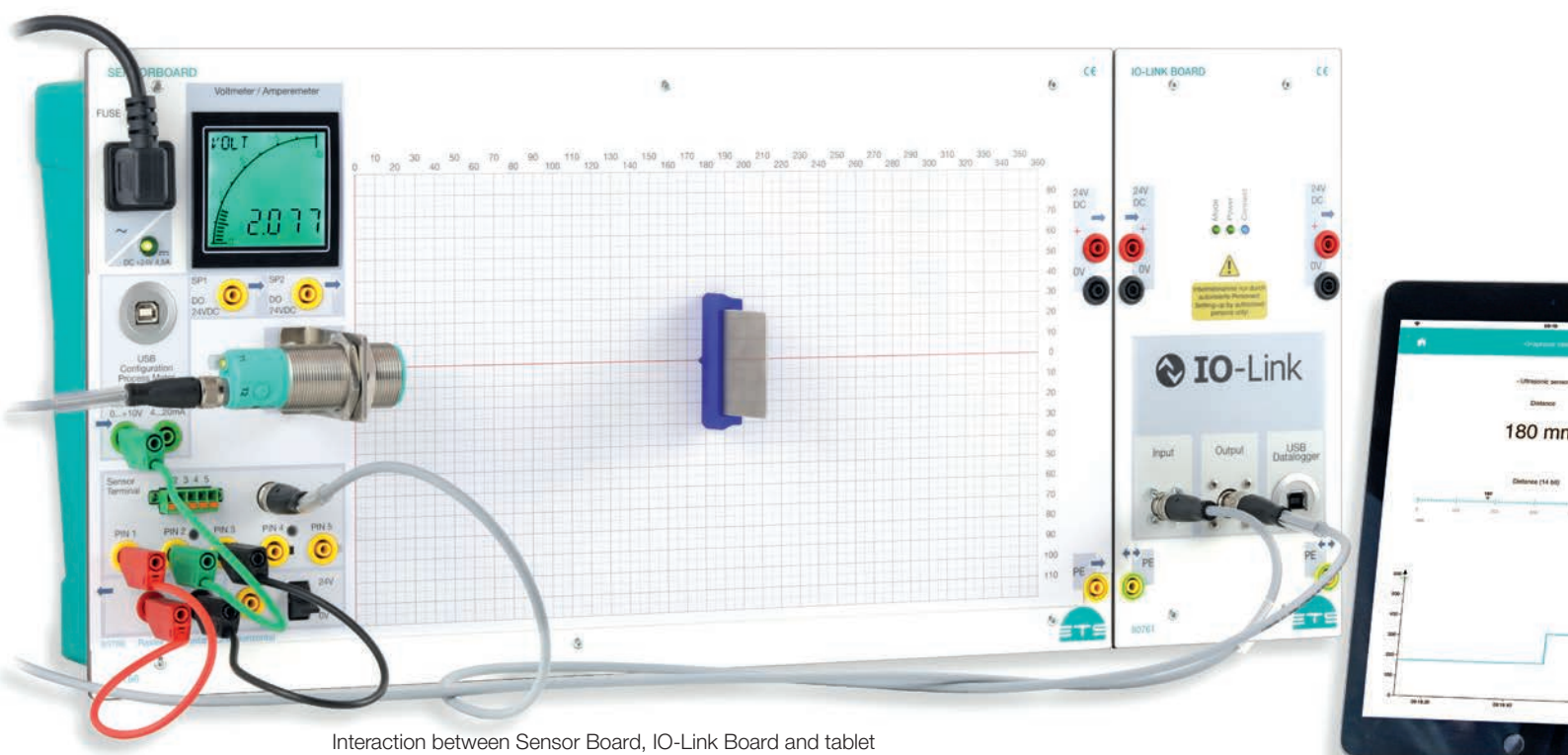
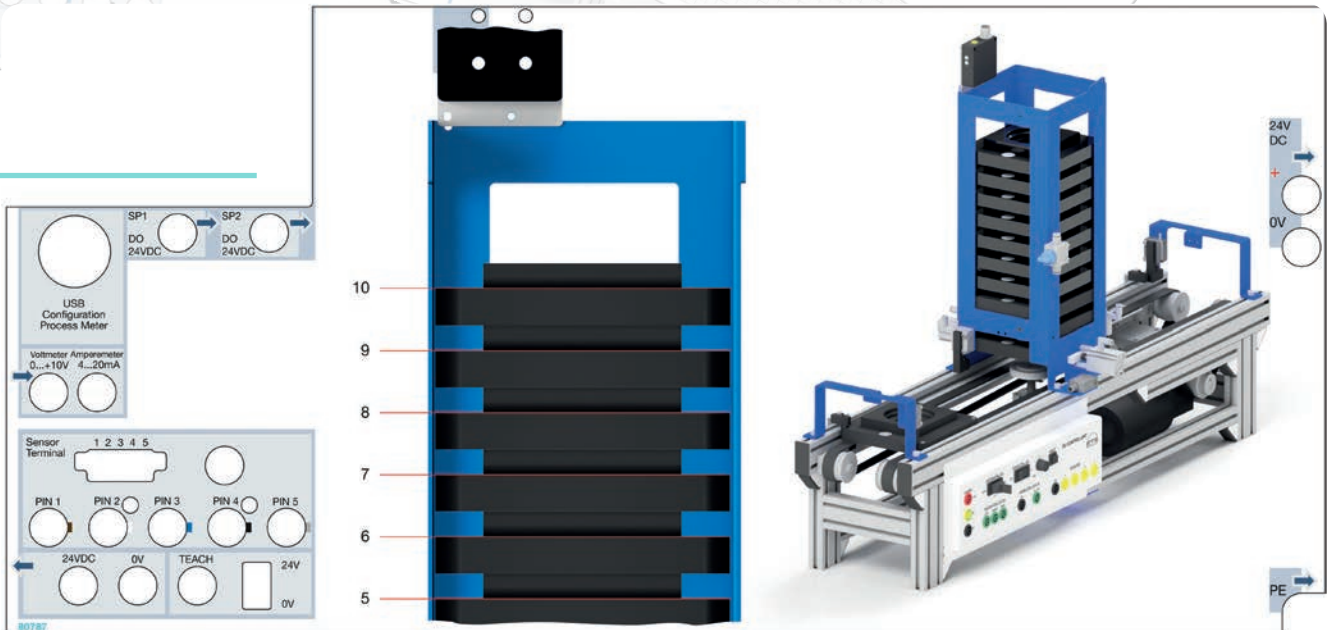
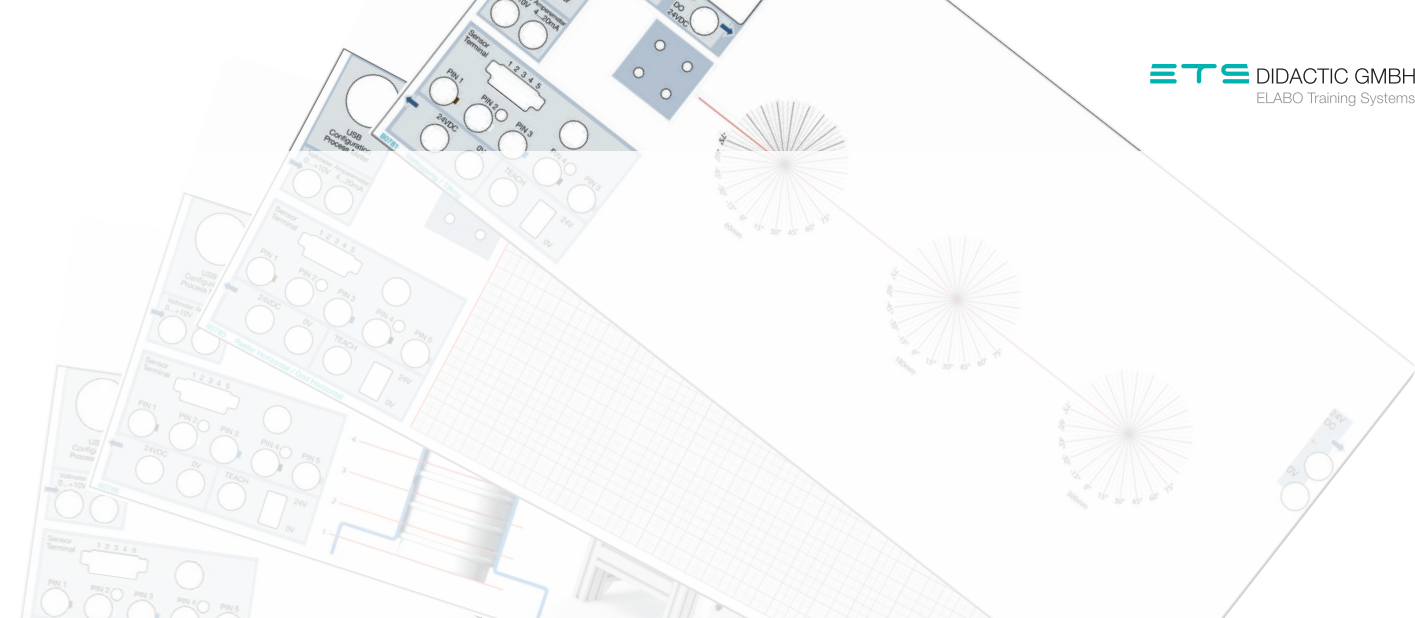

Interaction between Sensor Board, IO-Link Board and tablet

GEAR UNIT TECHNOLOGY – Planetary Gear

Hardware



57365

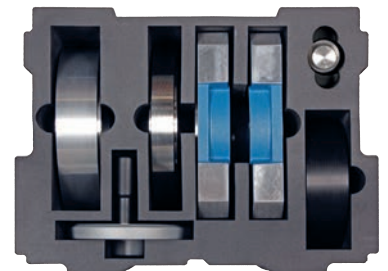
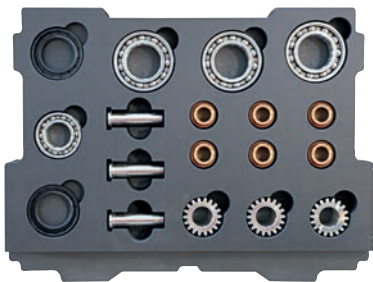

Courseware

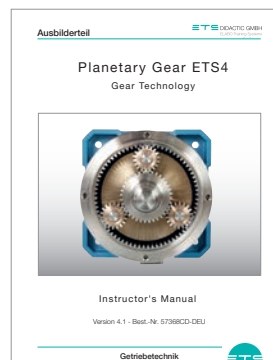
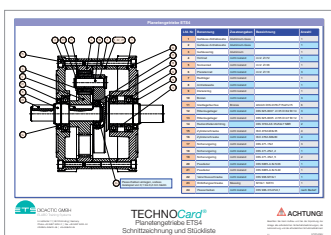
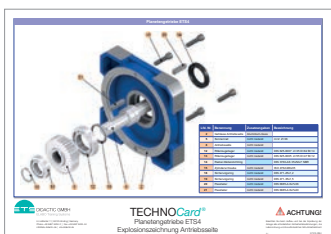

PROCESS ANIMATION

Assembly Group Gear Carrier

Scan
with APP



ETS DIDACTIC GMBH
ELABO Training Systems

ASSEMBLY INSTRUCTIONS Planetary Gear ETS4



3.2 Assembly Group Gear Carrier



Part No.	Designation	Quantity
6	Planet gear	3
7	Wheel carrier	1
9	Spacer ring	1
10	Bolt	3
11	Plain bearing bush	6
12	Grooved ball bearing DIN 625-6007	2
17	Locking snap ring DIN 471 – 15 x 1	3
19	Locking snap ring DIN 471 – 35 x 1.5	1
M3	Mounting aid „angular“	1

8

Assembly Group Gear Carrier

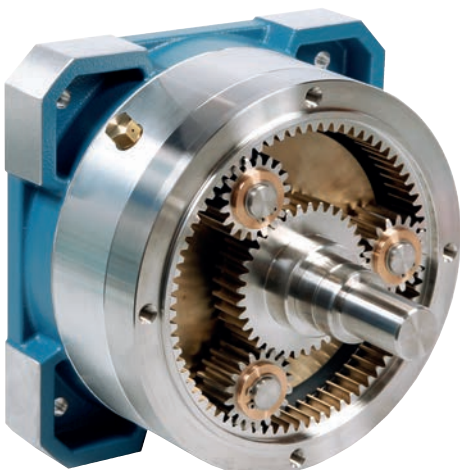

GEAR UNIT TECHNOLOGY – Worm Gear

Hardware



57365

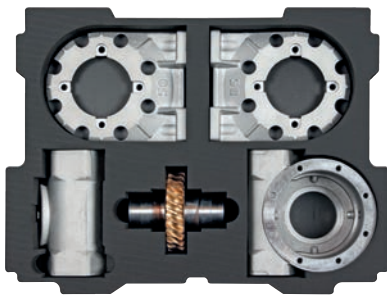

Courseware

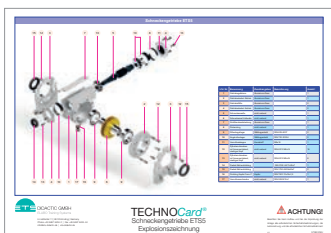
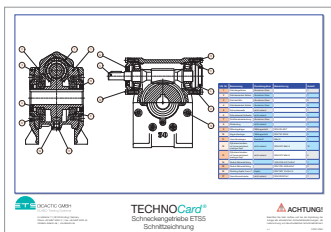

PROCESS ANIMATION

Assembly Gear Cover Input Side

Scan
with APP



ETS DIDACTIC GMBH
ELABO Training Systems

ASSEMBLY INSTRUCTIONS Worm Gear ETS5

 3.7 Assembly Gear Cover Input Side



o.	Designation	Quantity
	Gear cover input side	1
	Cylinder screws with hex socket head	

22

Assembly Gear Cover Input Side

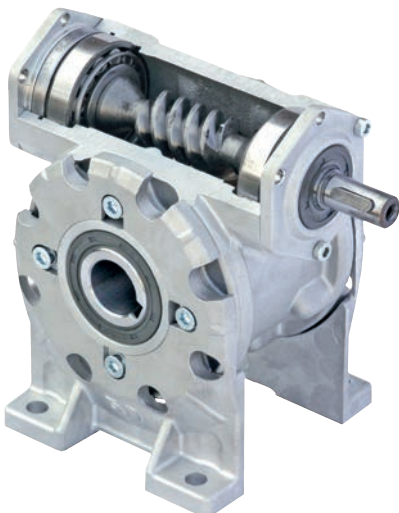

WE ARE HAPPY TO HELP
Information and Consulting



Bianca Reigl
Team Assistant

We accompany you and are at your side with active advice. Whether you need information, or some advice in advance of making an investment, or have questions regarding the daily use of the products:

Contact us – we would be happy to help:

ETS DIDACTIC GMBH
Service-Center
Im Hüttental 11
85125 Kinding / Germany

Phone +49 8467 8404-0
Fax +49 8467 8404-44

sales@ets-didactic.de
www.ets-didactic.de



Customer-oriented solutions

- › Presentation, product demonstrations and on-site consultancy
- › Support in the selection of educational systems according to the syllabus requirements
- › Matching of the training systems to customer requirements
- › Working out room concepts
- › Designing ergonomic workstations

Experience

- › Comprehensive range of innovative products
- › Systems and solutions from our own (in-house) production
- › Development and design, technical training systems
- › Quality right from the consultancy up to delivery and onward
- › Trainer seminars / In-house training
- › References world-wide
 - Industrial educational institutions
 - Vocational schools / technical schools
 - Chambers of crafts
 - Technical colleges / Universities

We support you

- › Installation and commissioning of the systems on-site
- › Technical support
- › Warranty and repairs
- › Instruction and training
- › Further education, training, seminars
- › Comprehensive product documentation
- › Courseware for instructors and trainees

EXCELLENCE IN TRAINING



Im Hüttental 11 | 85125 Kinding | Germany
Phone +49 8467 8404-0 | Fax +49 8467 8404-44
sales@ets-didactic.de | ets-didactic.de

Made
in
Germany

